

## Operating Manual

# Switching module RC-SM-4

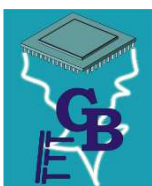

**BEIER-Electronic**  
Winterbacher Str. 52/4, 73614 Schorndorf - Weiler  
Telefon 07181/46232, Telefax 07181/45732  
eMail: [modellbau@beier-electronic.de](mailto:modellbau@beier-electronic.de)  
Internet: <http://www.beier-electronic.de/modellbau>

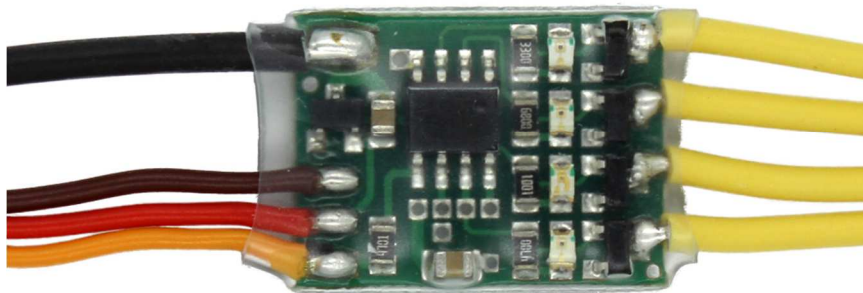
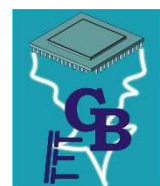

## Table of Contents

Table of Contents .....	2
Introduction .....	3
Safety notes.....	4
Additional information and help .....	4
Technical data .....	5
Wiring diagram .....	5
Division of the RC channel into areas.....	6
Setup – Selection of the switching mode.....	7
Change of mode settings with internal digital potentiometer.....	8
Mode 1: 4-way memory short / long .....	9
Mode 2: 2-way memory short / 2-way momentary long .....	10
Mode 3: 4-way memory via areas A, B, C, D.....	11
Mode 4: 4-way momentary via the areas A, B, C, D.....	12
Mode 5: 4-way memory via counting (EKMFA - A).....	13
Mode 6: 4-way memory via counting (EKMFA - D).....	14
Mode 7: Pulse when moving.....	15
Mode 8: 4-way light switch single (step switch) .....	16
Mode 9: 4-way light switch combined .....	17
Mode 10: Indicator (steering), hazard warning lights, light 1+2 .....	18
Mode 11: Indicator (memory), hazard warning lights, light 1+2 .....	19
Mode 12: Indicator (automatic shutdown), hazard warning lights, light 1+2 .....	20
Mode 13: Indicator (memory), light 1, light 2.....	21
Mode 14: Brake light, light, reversing light.....	22
Mode 15: Flasher, running light .....	23

## Introduction

With the switching module RC-SM-4, lights and other loads (e.g. motors, pumps, relays) can be switched directly via a channel of an RC remote control.

There are 4 outputs available on the switch module, which can be loaded with a current of up to 4 A. However, the total current of all outputs must not exceed 10 A.

The states of the 4 outputs are indicated by colored LEDs. It is easy to see which of the 4 outputs are currently switched on.

Output 1	green
Output 2	red
Output 3	blue
Output 4	yellow

The RC-SM-4 has 15 different switching modes that can be selected via setup:

Mode	Function	Control element
1	4-way memory short / long	Switch
2	2-way memory short / 2-way momentary long	Switch
3	4-way memory via areas A, B, C, D	proportional
4	4-way momentary via areas A, B, C, D	proportional
5	4-way memory via counting (EKMFA - A)	Switch
6	4-way memory via counting (EKMFA - D)	Switch
7	Pulse when moving	proportional
8	4-way light switch single (step switch)	Switch
9	4-way light switch combined	Switch
10	Indicator (steering), hazard warning lights, light 1+2	proportional (steering)
11	Indicator (memory), hazard warning lights, light 1+2	Switch
12	Indicator (automatic shutdown), hazard warning lights, light 1+2	Switch
13	Indicator (memory), light 1, light 2	Switch
14	Brake light, light, reversing light	proportional (throttle)
15	Flasher running light	Switch

When the RC-SM-4 is delivered, mode 1 is set.

For modes no. 3, 4, 7, 10 and 14, a proportional control (stick, slide control, rotary control) is required at the radio, since the RC-SM-4 has to evaluate proportional (stepless) signals here.

In all other modes, a 3-position switch on the radio is sufficient to control the outputs. However, proportional controller can also be used here.

## Safety notes

- Please read this operating manual carefully and keep it for future use!
- The integrated circuits on the switching module are sensitive to electrostatic charge. Therefore it is important that you don't touch these components, before discharging yourself (e.g. through a grip onto a grounded device).
- Under certain circumstances unfavourable placement and wiring of the switching module in the model may lead to restriction of transmitter range (mainly with 35/40 MHz transmitter).
- The switching module should only be used with supply voltages that are given in the technical data.
- Always switch off power first before connecting the module!
- The sound module is not suitable for children under 14 years.

## Additional information and help

You have problems with the module and need additional information?  
No worries, we are here to help you!

### **BEIER-Electronic forum**

Check out our [BEIER-Electronic forum](#) on our website. This is the most appropriate place to get quick and competent assistance. In our forum you can ask questions and receive practically proven answers from us and from other forum user. Through an intensive exchange of expertise and experience, all forum users can benefit from the information, presented solutions and ideas. Maybe your question / problem has already been described and you can find immediately the solution (e.g. in the [FAQ](#)).

### **BEIER-Electronic on facebook**

Also visit us on [facebook](#). You can find news and additional information about our products there. Customers of us also founded a [facebook group](#), where you can present your project and get help, just like in our forum.

## Technical data

<b>Supply Voltage:</b>	4.0 - 8.0 V (via RC receiver)
<b>Power consumption:</b>	approx. 10 - 25 mA
<b>Switching outputs:</b>	4 outputs negative switching
<b>Switching voltage:</b>	max. 20 V DC
<b>Switching current:</b>	max. 4 A per output Total current of all outputs: max. 10 A
<b>Switching modes:</b>	15 different switching modes, freely selectable
<b>Zero point of the RC signal:</b>	fixed at 1.500 ms
<b>Dimensions:</b>	20 x 15 x 4 mm
<b>Cable length:</b>	approx. 30 cm
<b>Weight:</b>	12 g

## Wiring diagram

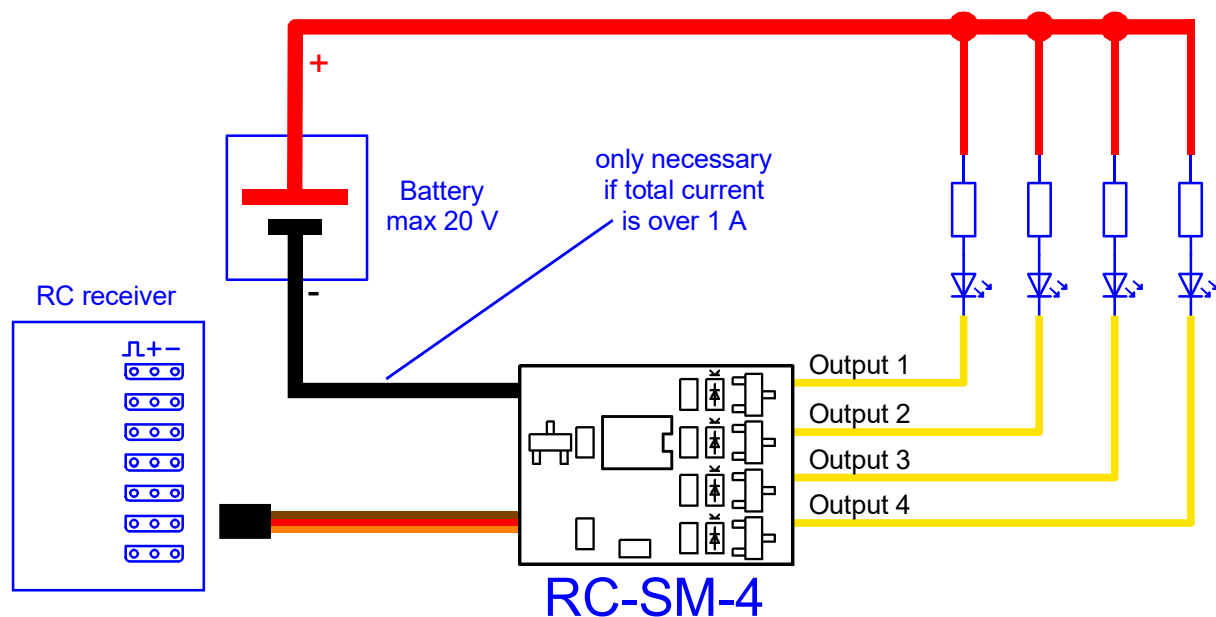

If the total current consumption of all connected loads exceeds the current of 1 A, the black cable of the RC-SM-4 must be connected to the negative pole of the battery. If only a few normal LEDs are connected, this is not necessary.

If the drive battery is not used to supply the connected loads, but a different battery, the black cable must also be connected.

When activating the setup (see page 7) and when changing the switching modes, the outputs of the RC-SM-4 are activated. This should be taken into account during the wiring and, if necessary, a pluggable / clampable connection should be selected if the activation of the outputs during the setup can lead to problems.

## Division of the RC channel into areas

To evaluate the different positions of a control element (stick, rotary control, slider, switch), the transmitter channel is divided into the 5 areas A, B, N, C and D:



The example above shows the division of areas with a horizontal stick. Depending on the radio type and channel reversion, "right" and "left" can also be swapped!

With a vertical stick, the image must be mentally rotated 90 ° to the right (area "A" is then above and "D" is below). The following also applies here: Depending on the type of radio and channel reversion, "top" and "bottom" can be swapped!

If a proportional control element is not used to control the RC-SM-4, but a 3-position switch, only areas A, N and D can be reached with this switch (without special programming in the radio). This is sufficient for many switching modes.

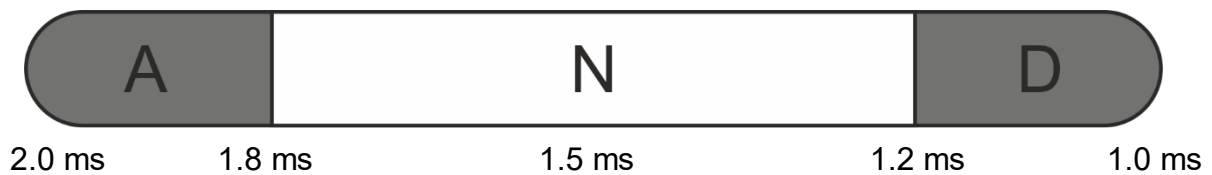

## Setup – Selection of the switching mode

**Attention: When activating the setup and when changing the switching modes, the outputs of the RC-SM-4 are activated! To be safe, the loads should possibly be disconnected from the 4 outputs before activating the setup.**

To change the switching mode, proceed as follows:

1. Unplug the servo cable of the RC-SM-4 from the receiver.
2. Switch on the radio and supply the receiver with voltage.
3. Now plug the servo cable of the RC-SM-4 into a receiver slot. Within the next 5 seconds, the transmitter control element must move quickly 3 times to full scale in area A (ie “up” or “left”) and 3 times in area D (ie “down” or “right”) become. This starts the setup and all 4 LEDs on the RC-SM-4 flash quickly for 4 seconds.

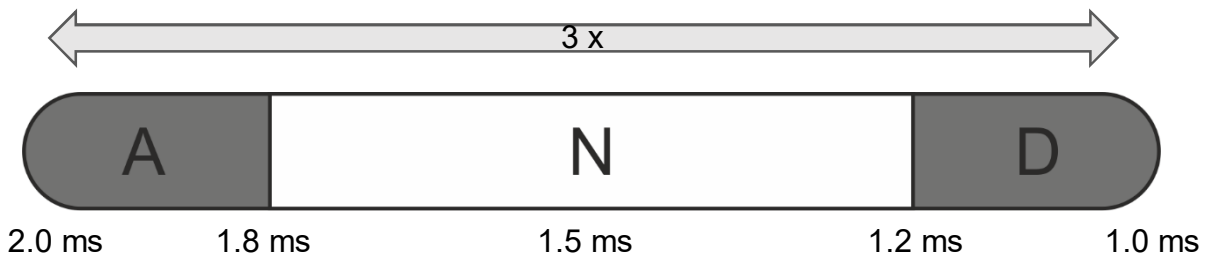

4. After the 4 seconds have elapsed, the number of the set mode is flashed out via the 4 LEDs on the RC-SM-4 (see table below).
5. The number of the desired mode can now be set using the control element on the transmitter. Each time it is briefly touched in areas A or D, the mode is increased or decreased by 1. The flashing of the LEDs always changes according to the set number.

Mode	Function	LEDs
1	4-way memory short / long	○○○★
2	2-way memory short / 2-way momentary long	○○★○
3	4-way memory via areas A, B, C, D	○○★★
4	4-way momentary via areas A, B, C, D	○★○○
5	4-way memory via counting (EKMFA - A)	○★○★
6	4-way memory via counting (EKMFA - D)	○★★○
7	Pulse when moving	○★★★
8	4-way light switch single (step switch)	★○○○
9	4-way light switch combined	★○○★
10	Indicator (steering), hazard warning lights, light 1+2	★○★○
11	Indicator (memory), hazard warning lights, light 1+2	★○★★
12	Indicator (automatic shutdown), hazard warning lights, light 1+2	★★○○
13	Indicator (memory), light 1, light 2	★★○★
14	Brake light, light, reversing light	★★★○
15	Flasher, running light	★★★★

If the transmitter control element is not operated for 30 seconds or the voltage of the RC-SM-4 is disconnected, the last setting selected is saved and the RC-SM-2 then works in the set mode.

This set mode remains until the setup is restarted and the mode is changed.

## Change of mode settings with internal digital potentiometer

Settings for some switching modes can be changed via an internal, virtual "digital potentiometer":

Mode	Function of the digital potentiometer	Potentiometer level (0 - 7)
7	Motion detection sensitivity	0 = very sensitive 7 = less sensitive
10	Adjustment of the neutral area	0 = 1.52 – 1.48 ms 7 = 1.80 – 1.20 ms
12	Number of flashes before automatic shutdown	0 = 2 flashes 7 = 9 flashes
14	Adjustment of the neutral area	0 = 1.52 – 1.48 ms 7 = 1.66 – 1.34 ms

For all other modes no settings can be changed with the "digital potentiometer".

The "digital potentiometer" has 8 levels (levels 0 - 7). To change the level, the setup is started first (see page 7). If the setup mode is activated (LEDs flash according to the set mode), the control element must now be moved to area D for at least 2 seconds. This activates the setting mode of the "digital potentiometer".

To display the current value, the yellow LED lights up continuously and the remaining 3 LEDs flash according to the set potentiometer value:

Potentiometer value	LEDs
0	● ○ ○ ○
1	● ○ ○ ★
2	● ○ ★ ○
3	● ○ ★ ★
4	● ★ ○ ○
5	● ★ ○ ★
6	● ★ ★ ○
7	● ★ ★ ★

The value of the "digital potentiometer" can be changed via areas A and D.

If the transmitter control element is no longer operated for 30 seconds or the voltage of the RC-SM-4 is disconnected, the last selected value is saved.



## Mode 1: 4-way memory short / long

If the control element (switch) is moved to area A or D, the corresponding output switches on and remains activated until this area is activated again. The output changes (toggles) its state each time it is activated.

A distinction is also made as to whether the area was activated short (less than 1 second) or long (more than 1 second).

Short in area A:	Output 1 switches on or off (memory)
Long in area A:	Output 2 switches on or off (memory)
Long in area D:	Output 3 switches on or off (memory)
Short in area D	Output 4 switches on or off (memory)

The intermediate areas B and C are not evaluated in this mode.

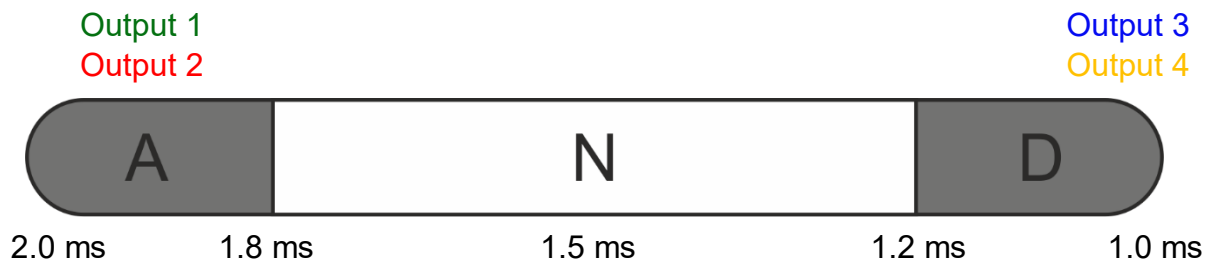

## Mode 2: 2-way memory short / 2-way momentary long

If the control element moved short (less than 1 second) to area A or D in this mode, the corresponding output switches on and remains activated until this area is short activated again. The output changes (toggles) it's state with each activation.

However, if the control element is placed in area A or D for a long time (more than 1 second), the corresponding output switches on and remains on until the area is left again.

Short in area A:	Output 1 switches on or off (memory)
Long in area A:	Output 2 switches on (momentary)
Long in area D:	Output 3 switches on (momentary)
Short in area D	Output 4 switches on or off (memory)

The intermediate areas B and C are not evaluated in this mode.

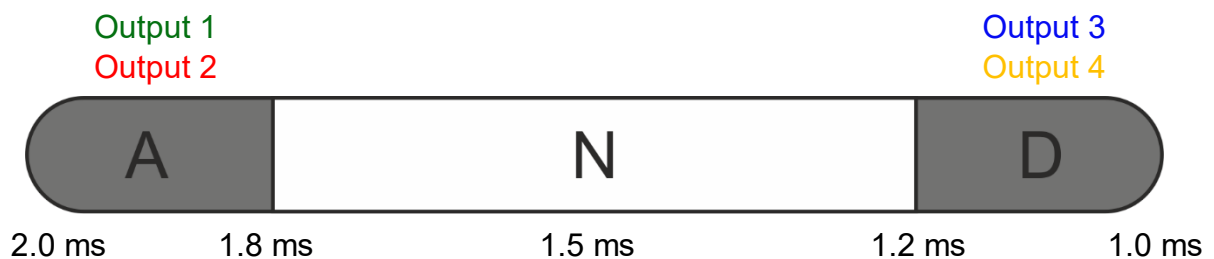

### Mode 3: 4-way memory via areas A, B, C, D

A proportional control element is required on the radio for this mode, since the intermediate areas B and C are also evaluated here.

If the control element is brought into an area (A, B, C or D), the corresponding output switches on and remains on until this area is activated again. The output always changes (toggles) its state with each activation.

In area A:	Output 1 switches on or off (memory)
In area B:	Output 2 switches on or off (memory)
In area C:	Output 3 switches on or off (memory)
In area D:	Output 4 switches on or off (memory)

Areas B and C have a delay of 1 second so that these areas are not triggered unintentionally when the control element is moved from neutral (N) through the intermediate areas (B and C) to the outer areas (A and D).

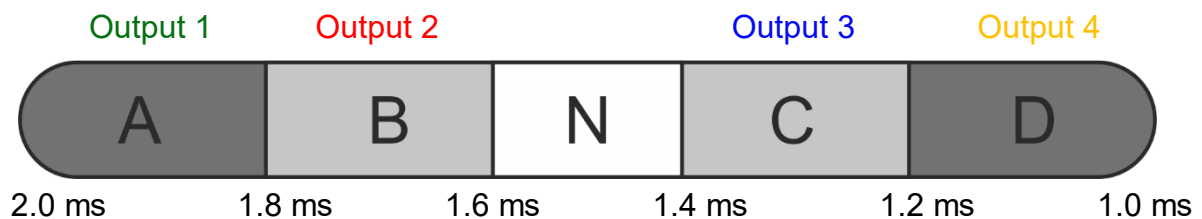

## Mode 4: 4-way momentary via the areas A, B, C, D

A proportional control element is required on the radio for this mode, since the intermediate areas B and C are also evaluated here.

If the control element is brought into an area, the corresponding output switches on and remains on as long as the control element is in this area. If the area is left, the output switches off again.

In area A:	Output 1 switches on (momentary)
In area B:	Output 2 switches on (momentary)
In area C:	Output 3 switches on (momentary)
In area D:	Output 4 switches on (momentary)

Areas B and C have a delay of 1 second so that these areas are not triggered unintentionally when the control element is moved from neutral (N) through the intermediate areas (B and C) to the outer areas (A and D).

In this mode, due to the switching method, no 2 or more outputs can be switched on at the same time.

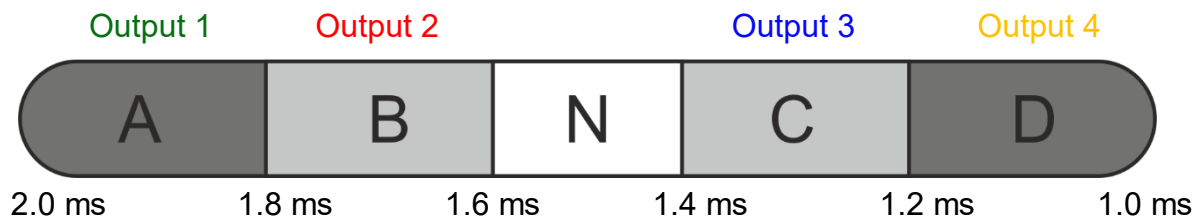

## Mode 5: 4-way memory via counting (EKMFA - A)

This mode works according to the counting principle (also known as EKMFA at our sound modules). Every time the control element is brought into area A, a counter is incremented. If there are no further counting pulses for 1 second, the output that corresponds to the count is switched on or off. The counter is then reset to 0.

The max. counter reading is 4. If, for example, the count is up to 5, output 4 is still switched.

1 x in area A:	Output 1 switches on or off (memory)
2 x in area A:	Output 2 switches on or off (memory)
3 x in area A:	Output 3 switches on or off (memory)
4 x in area A:	Output 4 switches on or off (memory)

Areas B, C and D are not evaluated in this mode.

Since this mode only needs a "half" RC channel (area A), a second RC-SM-4 could be connected to the same channel using a Y cable, which is set to mode 6 and evaluates area D. So up to 8 outputs could be switched via one channel (4 x area A with the first RC-SM-4 and 4 x area D with the second RC-SM-4).

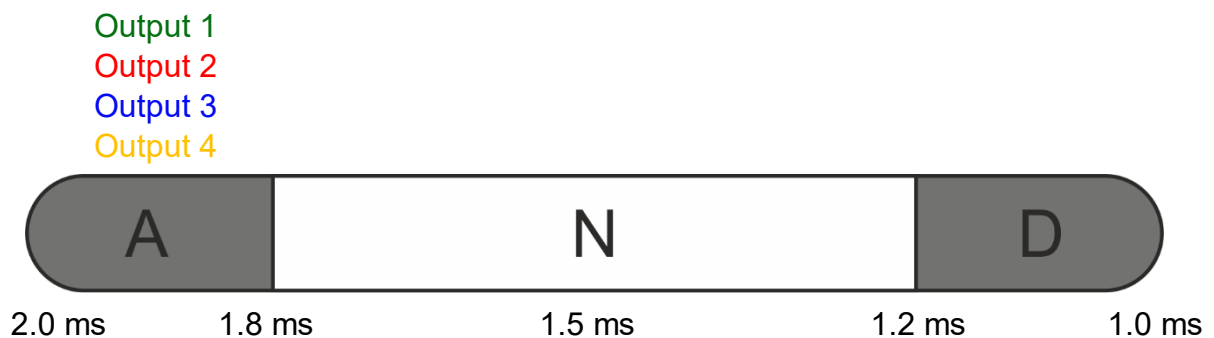

## Mode 6: 4-way memory via counting (EKMFA - D)

This mode works according to the counting principle (also known as EKMFA at our sound modules). Every time the control element is brought into area D, a counter is incremented. If there are no further counting pulses for 1 second, the output that corresponds to the count is switched on or off. The counter is then reset to 0.

The max. counter reading is 4. If, for example, the count is up to 5, output 4 is still switched.

1 x in area D:	Output 1 switches on or off (memory)
2 x in area D:	Output 2 switches on or off (memory)
3 x in area D:	Output 3 switches on or off (memory)
4 x in area D:	Output 4 switches on or off (memory)

Areas A, B and C are not evaluated in this mode.

Since this mode only needs a "half" RC channel (area D), a second RC-SM-4 could be connected to the same channel using a Y cable, which is set to mode 5 and evaluates area A. So up to 8 outputs could be switched via one channel (4 x area A with the first RC-SM-4 and 4 x area D with the second RC-SM-4).

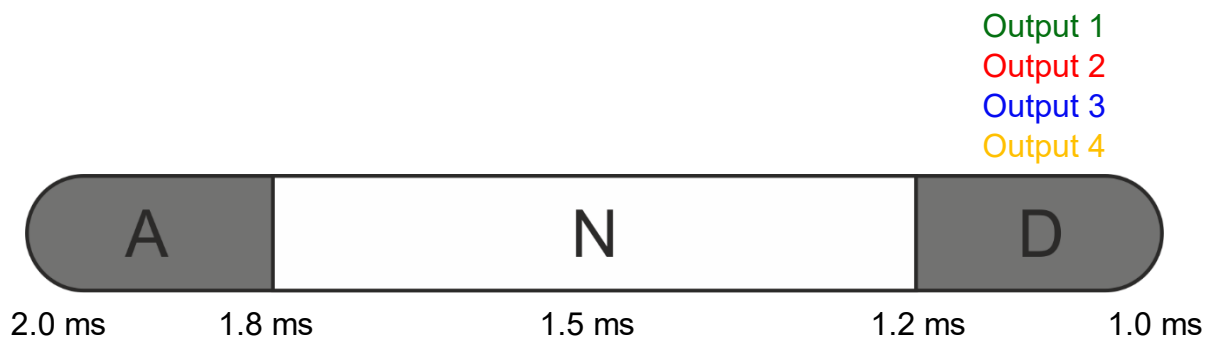

## Mode 7: Pulse when moving

A proportional control element is required on the radio for this mode, since a change in the proportional signal is evaluated here.

The 4 outputs switch on as long as the control element signal changes as follows:

Movement to left:	Output 1 switches on
Movement to right:	Output 2 switches on
Movement in area A:	Output 3 switches on
Movement in area D:	Output 4 switches on

If there is no more change, the outputs switch off again. The output only switches on as long as the control element is moving.

The sensitivity of the change monitoring can be set with the internal "digital potentiometer" (see page 8). The smaller the set value of the "digital potentiometer", the more sensitive the change monitoring is. With larger "digital potentiometer" values, the control element must therefore be moved more strongly in order to switch the outputs.

The outputs of the RC-SM-4 can also be combined by simple parallel connection, e.g. to generate an impulse, no matter in which direction or in which area the movement takes place.

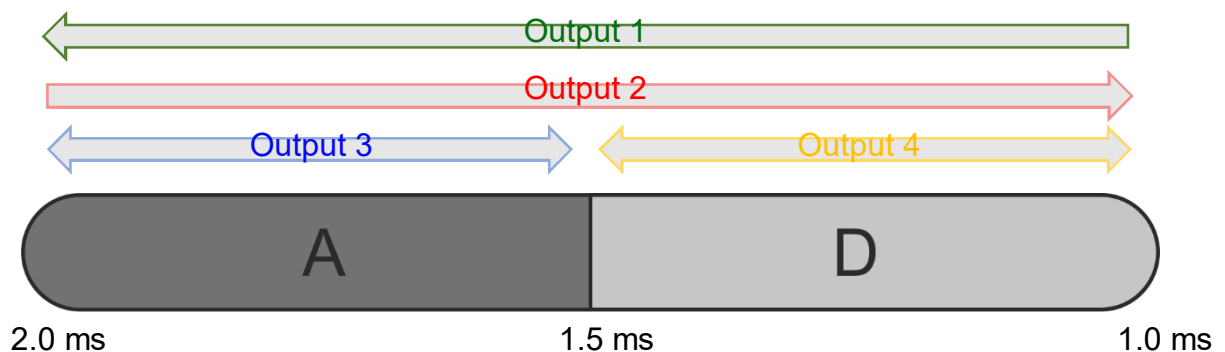

## Mode 8: 4-way light switch single (step switch)

In this mode the RC-SM-4 works like a kind of step switch with 5 steps (step 0 - step 4).

In the area A, the state of the light switch is increased by one step. In area D, the state of the light switch is reduced by one step.

Short in area A:	State of the light switch + 1
Short in area D:	State of the light switch - 1

Depending on the state of the light switch, the outputs are controlled as follows:

State	Output 1	Output 2	Output 3	Output 4
0	○	○	○	○
1	●	○	○	○
2	○	●	○	○
3	○	○	●	○
4	○	○	○	●

One output is always activated per state and all other outputs are off.

If the light switch is on state 4 and is increased by a further step, the state jumps again to 0. If the state of the light switch is on 0 and is reduced by another step, state jumps again to 4. The light switch therefore runs "in a circle".

The intermediate areas B and C are not evaluated in this mode.

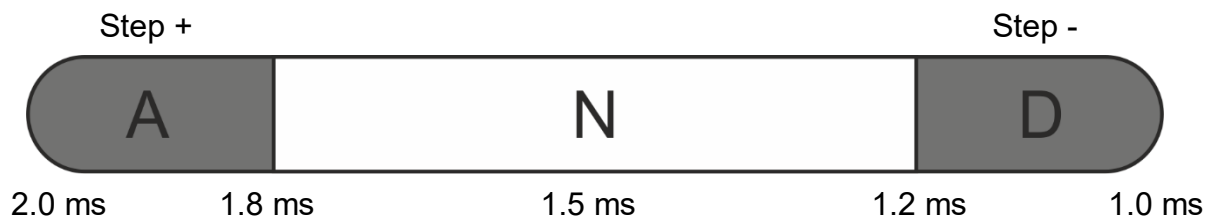



## Mode 9: 4-way light switch combined

In this mode the RC-SM-4 works like a kind of light switch with 5 steps (state 0 - state 4).

In the area A, the state of the light switch is increased by one step. In area D, the state of the light switch is reduced by one step.

Short in area A:	State of the light switch + 1
Short in area D:	State of the light switch - 1

Depending on the state of the light switch, the outputs are controlled as follows:

State	Output 1	Output 2	Output 3	Output 4
0	○	○	○	○
1	●	○	○	○
2	●	●	○	○
3	●	●	●	○
4	●	●	●	●

If the state is increased, 1 additional output is always switched on.

If the light switch is on state 4 and is increased by a further step, the light switch remains on state 4. If the state of the light switch is on 0 and is reduced by a further step, the light switch remains on state 0.

The intermediate areas B and C are not evaluated in this mode.

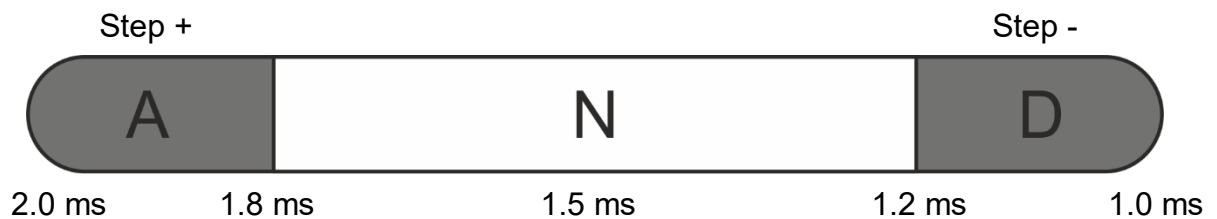

## Mode 10: Indicator (steering), hazard warning lights, light 1+2

In this mode the RC-SM-4 is connected to the receiver's steering channel with a Y-cable parallel to the steering servo. When steering around a curve, the indicators are automatically activated. The neutral position of the steering channel should be set to 1.500 ms on the transmitter.

In addition to the right and left indicators, 2 further outputs for 2 lights, as well as the hazard warning lights (right indicator and left indicator simultaneously) can be switched. To do this, the channel must be brought very shortly (max. 300 ms) to areas A or D and then immediately back to the neutral position.

Assignment of the outputs:

Output 1:	Indicator left
Output 2:	Light 1
Output 3:	Light 2
Output 4:	Indicator right

Control of the functions:

Short in area A:	1 x switches light 1 on (memory) 2 x switches light 2 on (memory) 3 x switches light 1 and light 2 off again
In area A:	Switches indicator left on (momentary)
In area D:	Switches indicator right on (momentary)
Short in area D:	Switches hazard warning lights on or off (memory)

The size of the neutral area can be changed using the "digital potentiometer" (see page 8):

Digital potentiometer value	Neutral area
0	1.52 – 1.48 ms
1	1.56 – 1.44 ms
2	1.60 – 1.40 ms
3	1.64 – 1.36 ms
4	1.68 – 1.32 ms
5	1.72 – 1.28 ms
6	1.76 – 1.24 ms
7	1.80 – 1.20 ms

The intermediate areas B and C are not evaluated in this mode.

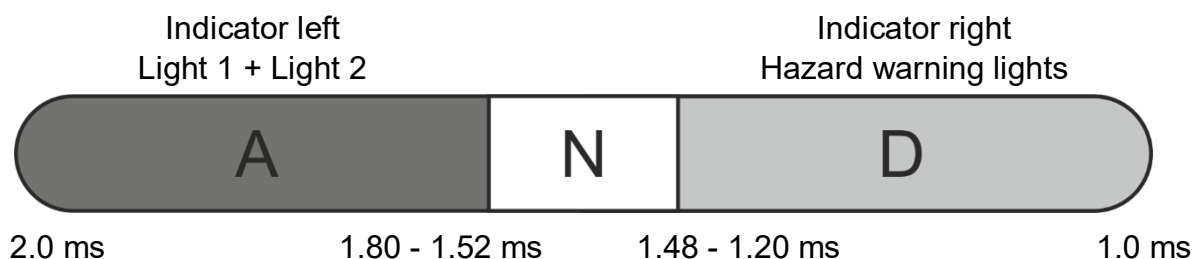

## Mode 11: Indicator (memory), hazard warning lights, light 1+2

Here the indicators are not controlled via the steering, but via a separate channel with a 3-position switch. If the indicators are switched on via the switch, they remain on until the switch is activated again.

Left indicator, right indicator and hazard warning lights switch off the other automatically as soon as they are activated.

In addition to the right and left indicators, 2 further outputs for 2 lights, as well as the hazard warning lights (right indicator and left indicator simultaneously) can be switched.

Assignment of the outputs:

Output 1:	Indicator left
Output 2:	Light 1
Output 3:	Light 2
Output 4:	Indicator right

Control of the functions:

Short in area A:	Switches indicator left on or off (memory)
Long in area A:	1 x switches light 1 on (memory) 2 x switches light 2 on (memory) 3 x switches light 1 and light 2 off again
Long in area D:	Switches hazard warning lights on or off (memory)
Short in area D:	Switches indicator right on or off (memory)

The intermediate areas B and C are not evaluated in this mode.

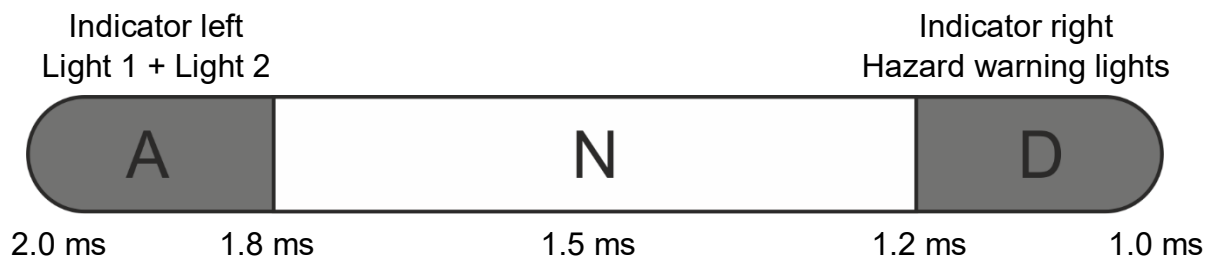

## Mode 12: Indicator (automatic shutdown), hazard warning lights, light 1+2

Here the indicators are not controlled via the steering, but via a separate channel with a 3-position switch. In contrast to mode 11, however, the indicators are automatically switched off again after an adjustable number of flashes.

How often the indicator should flash is determined by the "digital potentiometer" (see page 8):

Digital potentiometer value	Shutdown after flashing x times
0	2 x
1	3 x
2	4 x
3	5 x
4	6 x
5	7 x
6	8 x
7	9 x

Left indicator, right indicator and hazard warning lights switch off the other automatically as soon as they are activated. In addition to the right and left indicators, 2 further outputs for 2 lights, as well as the hazard warning lights (right indicator and left indicator simultaneously) can be switched.

Assignment of the outputs:

Output 1:	Indicator left
Output 2:	Light 1
Output 3:	Light 2
Output 4:	Indicator right

Control of the functions:

Short in area A:	Switches indicator left on or off (memory)
Long in area A:	1 x switches light 1 on (memory) 2 x switches light 2 on (memory) 3 x switches light 1 and light 2 off again
Long in area D:	Switches hazard warning lights on or off (memory)
Short in area D:	Switches indicator right on or off (memory)

The intermediate areas B and C are not evaluated in this mode.

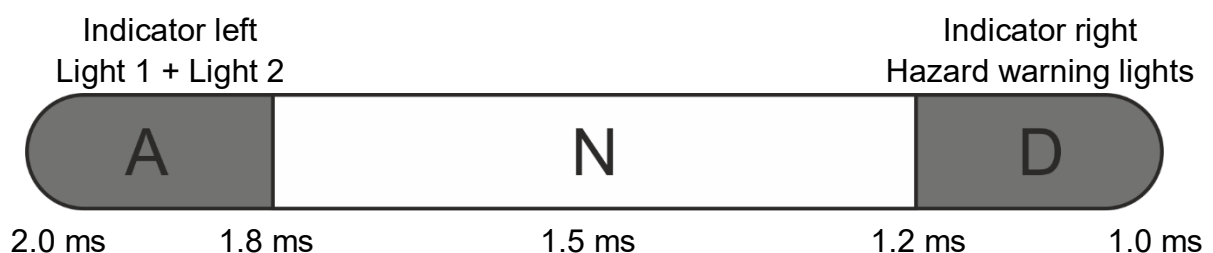

## Mode 13: Indicator (memory), light 1, light 2

Here the indicators are not controlled via the steering, but via a separate channel with a 3-position switch. If the indicators are switched on via the switch, they remain on until the switch is activated again.

In addition to the right and left indicators, 2 further outputs for 2 completely separately switchable lights can be switched.

The two indicators do not switch off each other in this mode! A hazard warning light can be implemented by switching on both indicators one after the other.

Assignment of the outputs:

Output 1:	Indicator left
Output 2:	Light 1
Output 3:	Light 2
Output 4:	Indicator right

Control of the functions:

Short in area A:	Switches indicator left on or off (memory)
Long in area A:	Switches light 1 on or off (memory)
Long in area D:	Switches light 2 on or off (memory)
Short in area D:	Switches indicator right on or off (memory)

The intermediate areas B and C are not evaluated in this mode.

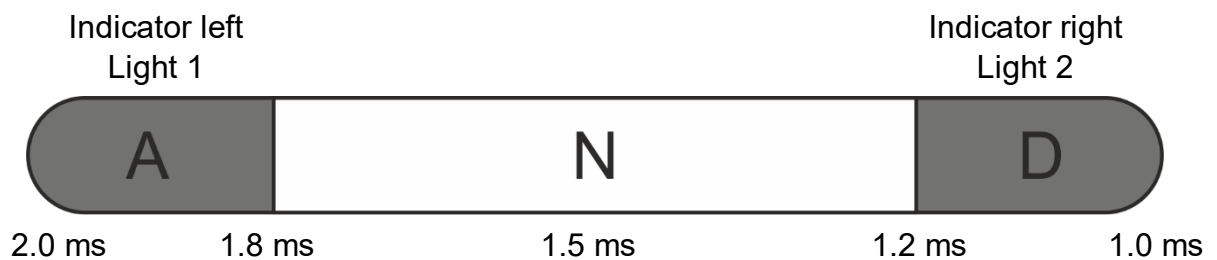

## Mode 14: Brake light, light, reversing light

In this mode the RC-SM-4 is connected to the throttle channel of the receiver with a Y-cable parallel to the speed controller. When driving the model, the brake light and reversing light are automatically activated. The neutral position of the throttle channel should be set to 1.500 ms on the transmitter.

A "normal" forward / reverse speed controller is required for this mode. Speed controllers with special functions such as cruise control, braking functions or pure forward controllers do not work.

There are 2 variants for the brake light:

- Without emergency brake light (Output 1)
- With emergency brake light (Output 2)

With the emergency brake light, the brake light flashes for approx. 2.5 seconds when the brakes are hard, in order to warn vehicles behind of a danger.

If the reversing light lights up when driving forward, the throttle channel on the radio must be reversed. This may make it necessary to teach-in the speed controller again.

In addition to the brake and reversing lights, there is an output for a light that is always switched on automatically as soon as the model starts moving. If the model stands for at least 30 seconds, the light is switched off again.

Assignment of the outputs:

Output 1:	Brake light without emergency brake light
Output 2:	Brake light with emergency brake light
Output 3:	Light
Output 4:	Reversing light

The size of the neutral area can be changed using the "digital potentiometer" (see page 8):

Digital potentiometer value	Neutral area
0	1.52 – 1.48 ms
1	1.54 – 1.46 ms
2	1.56 – 1.44 ms
3	1.58 – 1.42 ms
4	1.60 – 1.40 ms
5	1.62 – 1.38 ms
6	1.64 – 1.36 ms
7	1.66 – 1.34 ms

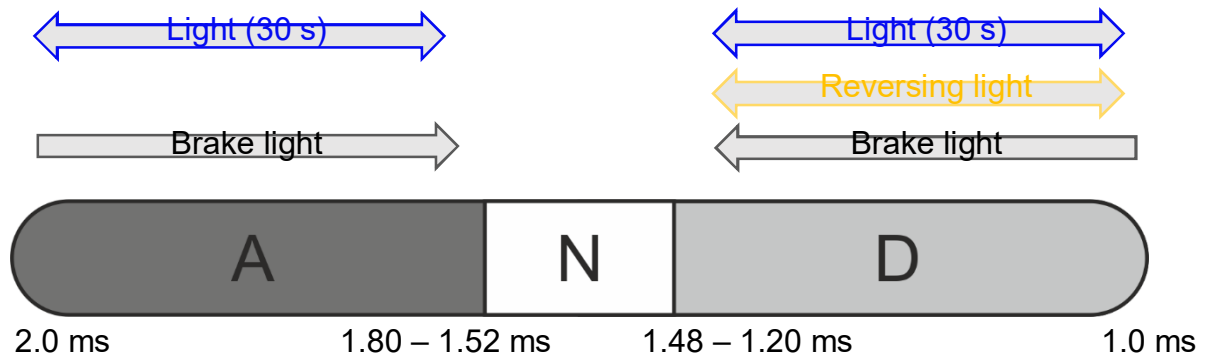

**Mode 15: Flasher, running light**

In this mode there are 4 different variants of flashers / running lights to choose from:

Variant 1:	<p>4-way und 2-way flasher</p> <p>Output 1: </p> <p>Output 2: </p> <p>Output 3: </p> <p>Output 4: </p>
Variant 2:	<p>2-way und 1-way flasher</p> <p>Output 1: </p> <p>Output 2: </p> <p>Output 3: </p> <p>Output 4: </p>
Variant 3:	<p>Running light</p> <p>Output 1: </p> <p>Output 2: </p> <p>Output 3: </p> <p>Output 4: </p>
Variant 4:	<p>Running light – Knight Rider</p> <p>Output 1: </p> <p>Output 2: </p> <p>Output 3: </p> <p>Output 4: </p>

The speed of the light sequences can be changed in 8 steps. If the fastest speed is reached at level 8 and the level is increased again, the system switches back to the slowest level 1.

Control of the functions:

Short in area A:	Switches flasher / running light on or off (memory)
Long in area A:	
Long in area D:	Change variant of the flasher / running light
Short in area D:	Increase speed by 1 step

As a special feature, the RC-SM-4 always remembers its state (on or off), the last selected variant and the last set speed in this mode. These states are restored each time the supply voltage is applied via the servo connector. After it has been appropriately set and switched on, the RC-SM-4 can also be used as a “standalone” flashing / running light module - without any RC transmitter or receiver.

The intermediate areas B and C are not evaluated in this mode.

