

Operating Instructions

Infrared Light Module LM-IR-16-4 V1.01

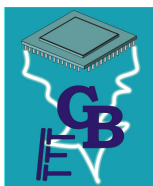

BEIER-Electronic
Winterbacher Str. 52/4, 73614 Schorndorf - Weiler
Telefon 07181/46232, Telefax 07181/45732
eMail: modellbau@beier-electronic.de
Internet: <http://www.beier-electronic.de/modellbau>

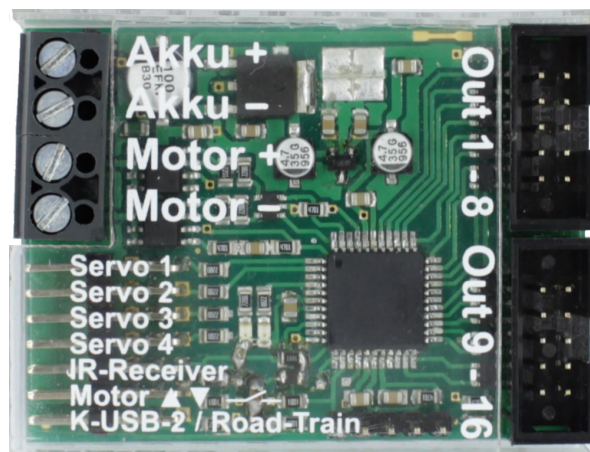
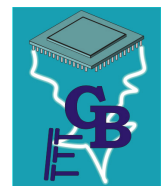

Table of Contents

Table of Contents	2
Description.....	3
Safety advisory	4
Technical data	4
Pin assignment.....	5
Wiring diagram	6
Supply voltage connection.....	6
Connection of IR transmitter diode and IR receiver.....	6
Connection of outputs	8
Connection of servos.....	9
Connection of motor	9
Connection of switch for manual motor control	10
Connection of data cable K-USB-2.....	10
Road train.....	10
Switching outputs	11
Special light functions at outputs 13 - 16.....	12
Controlling the servo outputs.....	13
Controlling the motor output	14
Green LED on LM-IR-16-4	14
PC software „LM-Teacher“	15
Using software „LM-Teacher“	16
Diagnosis.....	18
Firmware update.....	20

Description

The infrared light module LM-IR-16-4 is an expansion module for the modules SFR-1, USM-RC-2, USM-RC-3 and UFR-1230.

The light module can be used to control lights, servos and motors on a (truck) trailer or semitrailer. The signals are transmitted wirelessly via an infrared diode. Connecting cables from the towing vehicle to the trailer are therefore not necessary. A separate battery is required in the trailer or semitrailer for the supply voltage of the light module.

The LM-IR-16-4 has 16 switching outputs for connecting the lighting (e.g. lamps and LEDs). The light signals are passed on from the main module to the light module. For the switching outputs 13 - 16, special functions such as a 1- and 4-channel all-round light, a 4-channel running light and different flashing effects can be selected. A detailed assignment of the switching outputs in combination with the various modules can be found on page **Fehler! Textmarke nicht definiert..**

A motor output can be used for direct control of e.g. trailer supports, ramps or tipping movements. An optional switch for controlling the motor output manually can be connected to the module as well.

There are also 4 servo outputs to control (servo) movements. Applications for this are e.g. trailer supports, the locking and unlocking of a seat post, steerable axles, or tipping movements. Speed controllers can be connected to the servo outputs to control additional motors.

When delivered, the light module is ready for operation with the standard settings. With the LM-Teacher software, many settings can be adjusted and additional options can be selected. For this purpose, the light module is connected to a Windows PC with the data cable [K-USB-2](#).

In order to be able to control the LM-IR-16-4 via the SFR-1, USM-RC-2 or USM-RC-3, the light module must be activated in the sound teachers of the main modules. For this, at least version V1.30 of the SFR-1 Sound-Teacher and version V1.80 of the USM-RC-2 Sound-Teacher are required. Version V1.30 of the Drive-Teacher is required for the UFR-1230.

Safety advisory

- Read these operating instructions carefully before activation and keep them on hand for future usage!
- The integrated circuits on the light module are sensitive to electrostatic charges. You must “discharge” yourself (e.g. by touching a heater or another grounded device) before touching any component.
- The light module should only be operated with the supply voltage specified in the technical data.
- Wiring work may only be conducted in a non-energized state.
- Children under the age of 14 are not permitted to operate the light module.

Technical data

Supply voltage (U_b):	6 – 12 V DC
Current consumption:	Quiescent current: approx. 25mA
Switching outputs:	16 pieces (minus-switching, N-channel MOSFET), max: 1.5 A per output, the total current of all outputs must not exceed 3,0 A.
Light functions:	<ul style="list-style-type: none"> • 1:1 copy of 16 outputs of SFR-1 • 1:1 copy of 12 outputs of USM-RC-2 • 1:1 copy of 16 outputs of USM-RC-3 • 1:1 copy of 8 outputs of UFR-1230 • 1- or 4-channel all-round light • 4 different flashers • 4-channel running light
Servo outputs:	4 pieces (1,000 - 2,000 ms), max. current consumption of servos: 1 A (short time 4 A)
Motor output:	1 piece, max. current consumption of motor: 2 A (short time 3 A)
Additional ports:	<ul style="list-style-type: none"> • IR receiver • Switch to control motor manually • Data cable / IR-transmitter for a Road-Train
Permissible ambient temperature:	0 – 60° C
Permissible relative air humidity:	Max. 85 %
Dimensions:	58 x 44 x 17 mm
Weight:	26 g

Pin assignment

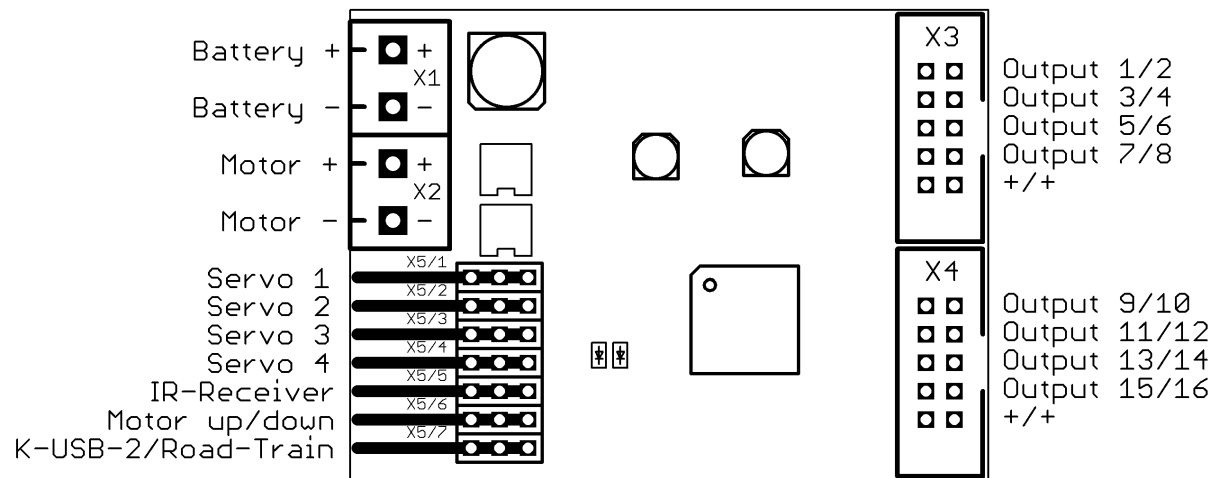

Anschlüsse auf dem Lichtmodul:

X1/+	Akku + (6 – 12 V)
X1/-	Akku -
X2/+	Motor +
X2/-	Motor -
X3	Outputs 1 - 8
X4	Outputs 9 - 16
X5/1	Servo 1
X5/2	Servo 2
X5/3	Servo 3
X5/4	Servo 4
X5/5	IR receiver
X5/6	Switch to control motor manually
X5/7	Data cable K-USB-2 / IR-transmitter diode for a Road-Train

Wiring diagram

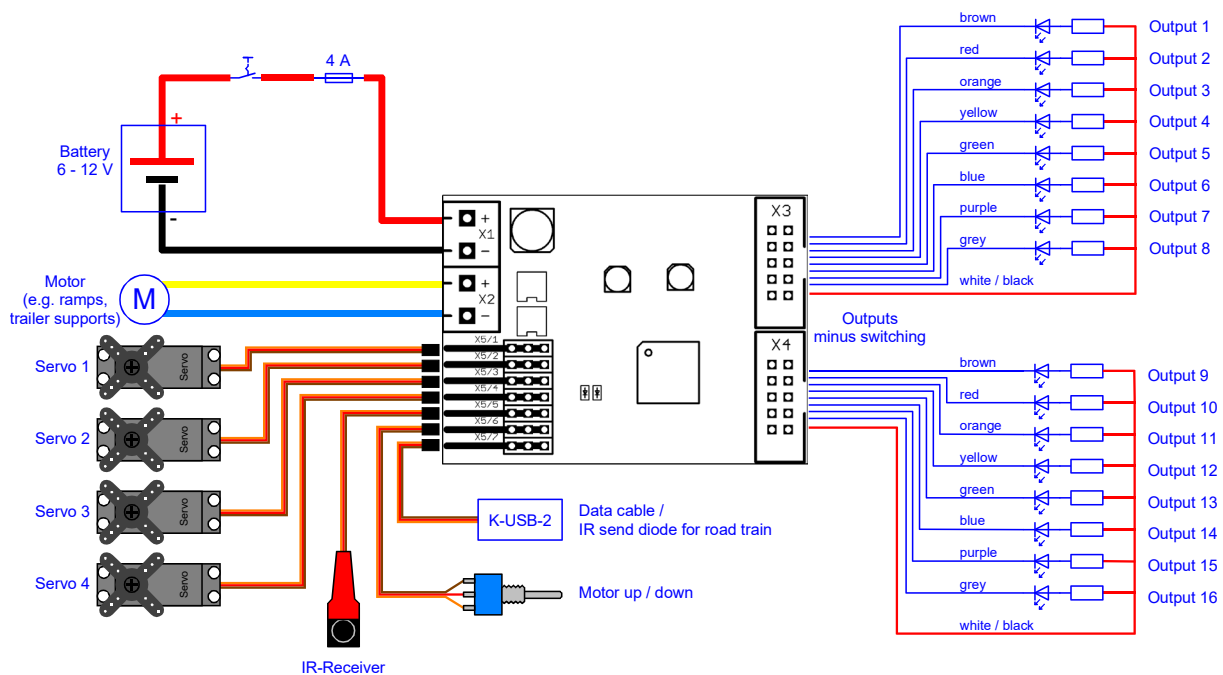

All wiring work must be conducted while power supply is turned off!

Supply voltage connection

The LM-IR-16-4 requires a DC voltage of 6 - 12 V (e.g. a battery) for supply voltage. This is connected to terminal X1. Please pay attention to the correct polarity! Reverse polarity can destroy the module!

The cable cross-section for the supply voltage should be as large as possible (0.75 mm² - 1.5 mm²).

In addition, a switch for switching off the light module and a fuse with 4 A should also be installed in the supply line (positive line).

Connection of IR transmitter diode and IR receiver

IR transmission:

The prerequisite for the function of the light module LM-IR-16-4 is a sound speed controller SFR-1, a sound module USM-RC-2/USM-RC-3 or a speed controller UFR-1230! Operation with other sound modules / speed controller is not possible.

With the modules USM-RC-2, USM-RC-3 and SFR-1, you can choose between two different IR protocols (slow and fast). With the UFR-1230 there is only 1 protocol and this is activated automatically.

The distance between the IR transmitter diode and the IR receiver should not be larger than 10 cm to ensure reliable transmission.

If the IR transmission works correctly, the green LED on the light module flashes fast at regular intervals. If the light module does not receive any IR signals for more than 2 s, all outputs are switched off, the motor is stopped and the servos move (depending on the setting) to the neutral position.

Connection of IR transmitter diode:

The supplied IR transmitter diode (blue, round) is supplied with a soldered cable with a 3-pin plug.

With the SFR-1 sound speed controller, the black plug is plugged into the pin header X5/I. The brown cable points outwards, towards the edge of the board.

With the USM-RC-2 sound module, the black plug is plugged to X9. The brown cable points to the SD card, the orange cable in the direction of the gray terminal strip X1.

With the USM-RC-3 sound module, the black plug is plugged to X10. The brown cable points outwards, towards the edge of the board.

With the UFR-1230 speed controller, the black plug is plugged to X6/2, the brown cable points outwards to the edge of the board.

Connection of IR receiver:

The IR receiver (black, rectangular) is supplied with a soldered cable with a 3-pin plug. The black plug is plugged into the pin strip X5/5 on the light module. The orange cable points upwards.

The sensitive side of the receiver is the semicircular dome. So the IR transmitter diode should point to it.

For easy and stable mounting of the IR receiver, we offer the [KB-IR-T](#) king pin for Tamiya trucks with a special bracket in which the receiver can be clamped. For the transmission of the infrared signal, the king bolt has a continuous hole.



Connection of outputs

The outputs 1 - 16 of the module are on the socket headers X3 and X4.

The [ribbon cable](#) supplied can be used to connect the outputs. For a simple connection (without soldering) the connection terminals [AKL-8](#) and [AKL-8-W](#) can also be ordered from us in our shop.

Of course, other cables/plugs can also be connected to pin strips X3 and X4. A cable cross-section of 0.14 mm² - 0.5 mm² should be used for the switching outputs.

The light module always switches the negative pole to the connected load for all outputs. The negative pole of the load is connected to the output of the light module (see [connection diagram](#)).

The common positive pole for outputs 1 - 8 and 9 -16 are the black and white cables of the ribbon cable. It is also possible to connect the load directly to the positive terminal of the battery.

Assignment of ribbon cable:

Output	Ribbon cable (X3)
1	brown
2	red
3	orange
4	yellow
5	green
6	blue
7	purple
8	grey
positive pole	white
positive pole	black

Ausgang	Ribbon cable (X4)
9	brown
10	red
11	orange
12	yellow
13	green
14	blue
15	purple
16	grey
positive pole	white
positive pole	black

The switched voltage at the outputs (at 100 % brightness) is always as high as the supply voltage of the module.

If LEDs are connected, series resistors must always be used. It does not matter whether the series resistors are connected to the plus or minus line. The correct polarity is important for LEDs, otherwise they do not light up.

The required series resistors for the LEDs depend on the LED colors and the LED current. For orientation, here is a table with series resistors for standard LEDs (current approx. 15 mA) as a rough guide:

Supply voltage	Series resistor
6 V	270 Ohm
7,2 V	330 Ohm
8,4 V	470 Ohm
9,6 V	510 Ohm
12 V	680 Ohm

There are also LED series resistor calculators on the Internet (e.g. www.leds.de/widerstandsrechner) with which the ideal resistance can be calculated quickly and easily.

If relays or other inductive loads (e.g. motors) are connected to the switching outputs, free-wheeling diodes (e.g. 1N4007) must be used.

Connection of servos

4 servos or speed controllers as well as other modules that are intended for direct connection to a receiver (e.g. relay modules, rotating beacons, etc.) can be connected to the pin headers X5/1 - X5/4.

The orange cable points upwards.

If a speed controller is connected that has a BEC, the red wire must be removed from the servo plug and isolated! This is necessary because the LM-IR-16-4 has its own BEC, which is connected to the connections of the servo outputs.

The current consumption of all connected servos / modules at X5/1 - X5/4 must not exceed 1 A (short time 4 A)! Otherwise an external BEC is necessary.

Connection of motor

A motor for e.g. trailer supports, ramps or tipping functions can be connected to terminal X2. It is important that the current consumption of the motor does not exceed 2 A (short time 3 A).

Connection of switch for manual motor control

An optional switch [LM-SW](#) can be connected to pin strip X5/6, with which the motor can be controlled manually. For example, the trailer supports can be moved without remote control. The speed of the motor in manual mode is set in the LM-Teacher.



Connection of data cable K-USB-2

The data cable [K-USB-2](#) is connected to the pin header X5/7. The orange cable points upwards.

The light module is not supplied with voltage via the data cable. If the data cable is to be used, the LM-IR-16-4 must be supplied with voltage via the battery (as normal).

The data cable is used to transfer and read out the settings of the light module. The diagnosis can be used to check functions and search for errors. The data cable is also required for a firmware update.

Road train

An [IR transmitter diode](#) can also be connected to pin header X5/7, which then forwards the received IR signal 1: 1 to another light module. In this way, a road train can be implemented with several trailers.

Simultaneous operation of the data cable and the IR transmitter diode at X5/7 is not possible! However, it can be plugged between the data cable and the IR transmitter diode at any time.

All light modules of the road train always receive the same light signals for the 16 switching outputs. The signals for the 4 servo outputs and the motor output are also initially identical for all light modules. Using the functions "LM: Activate road train ID 1" - "LM: Activate road train ID 7" on the towing vehicle, however, the servo outputs and the motor output can be controlled very specifically with just one light module. The road train ID can be set in the LM-Teacher (see page 17)

If, for example, the "LM: Activate road train ID 2" function is switched on via the towing vehicle, the commands for the servo outputs and the motor output only affect the light module that has ID 2. With all other light modules, the servo outputs and motor outputs remain in the last state.

If no ID is selected on the towing vehicle, the commands for the servos and the motor output are always carried out by all light modules. This is always the initial state after switching on.

Switching outputs

The outputs are usually copies (forwarded signals) of the outputs of the module that sends the IR signals to the LM-IR-16-4. This means that whenever an output is activated on the SFR-1, USM-RC-2 or UFR-1230, the output with the same number on the LM-IR-16-4 also switches with the same intensity.

Example:

Output 4 is configured on the sound module as "indicator right". When the right turn signal is switched on, output 4 on the sound module (indicator signal for the truck) and output 4 on the light module (indicator signal for the trailer) at the same time. The brightness of the output of both modules corresponds to the settings in the Sound-Teacher.

Control via sound speed controller SFR-1:

The outputs 1 - 16 of the LM-IR-16-4 are 1: 1 copies of the outputs 1 - 16 of the SFR-1.

Control via sound module USM-RC-2:

The outputs 1 - 12 of the LM-IR-16-4 are 1: 1 copies of the outputs 1 - 12 of the USM-RC-2.

If servo outputs 1 and 2 are activated on the USM-RC-2, outputs 11 and 12 on the sound module cannot be used. However, these two outputs can still be used on the LM-IR-16-4.

The outputs 13 - 16 can only be used for the special functions "all-round light", "flashing light" and "running light".

Control via sound module USM-RC-3:

The outputs 1 - 16 of the LM-IR-16-4 are 1: 1 copies of the outputs 1 - 16 of the USM-RC-3.

Control via speed controller UFR-1230:

Outputs 1 - 8 of the LM-IR-16-4 are 1: 1 copies of outputs 1 - 8 of the UFR-1230.

The outputs 9 - 16 can be switched separately here.

Special light functions at outputs 13 - 16

The 4 outputs 13-16 have special light functions:

- Rotating beacon (1x4-channel or 4x1-channel)
- Indicator / flashing effects
- Running light (4-channel)

The special light functions are permanently assigned to these outputs and cannot be used for other outputs.

If the special light functions are to be used on outputs 13 - 16, these must be activated in the LM-Teacher (see page 17).

There are different variants for the rotating beacon and the running light, which can be set with the LM-Teacher software (see page 17).

The speed of the special light functions can also be set with the LM-Teacher.

1-channel rotating beacon (4 pieces)

This function simulates a rotating rotating beacon with one output. Of course, the light cannot really rotate, so the effect is achieved by constantly increasing and decreasing the brightness. This creates the impression of a rotating light (from the distance).

There are in total 4 of the 1-channel rotating beacons at the outputs 13-16. The speeds of the 4 rotating beacon are intentionally slightly different. So they are not running in sync.

The speed of the 1-channel rotating beacon can be adjusted with the LM-Teacher.

4-channel rotating beacon (1 piece)

The 4-channel rotating beacon is an improved version of the 1-channel all-round light. Here a rotating rotating beacon is simulated with 4 outputs. Of course, the 4 connected lamps/LEDs do not really rotate, but here too the effect is achieved by increasing and decreasing the brightness of the 4 outputs.

The speed of the 4-channel rotating beacon can be adjusted with the LM-Teacher.

Flasher/indicators (4 pieces)

If the flasher are activated, the outputs 13 - 16 flash in different rhythms. These 4 outputs are always activated at the same time. A combination of these outputs can create interesting effects (e.g. modern police flashing lights with 3 LEDs at outputs 13, 14 and 15).

Output 13:	Short lightning pulse
Output 14:	Short lightning double pulse
Output 15:	Short double lightning pulse, slightly offset in time to output 14.
Output 16:	Indicator

The speed of the flashers / blinkers can be set with the LM-Teacher

Running light (4-channel)

A 4-channel running light can be generated via the 4 outputs 13 - 16.

As an option it can be chosen whether the running light only runs in one direction or always back and forth (Knight Rider).

The speed of the running light can be adjusted with the LM-Teacher

Activation of special light functions

The 4 special light functions can be activated via the free function assignment in the Sound-Teacher or Drive-Teacher, via the proportional channels, the Nautic mode, the EKMFA mode or the switching inputs.

The functions are called in the Sound-Teacher:

- LM: Rotating beacon
- LM: Flasher
- LM: Running light

Controlling the servo outputs

Four servos or speed controllers can be connected to the light module. All 4 servo outputs can be controlled separately from each other.

In case of an interruption of the IR signal, it can be set whether the servos should move to neutral position (middle), or keep the last position.

For each servo output, a basic position and two additional servo positions can be specified in the Sound-/Drive-Teacher. The speed of movement can also be set in the Sound-Teacher.

The programmed positions can be activated via the free function assignment in the Sound-/Drive-Teacher, via the proportional channels, the nautic mode, the EKMFA mode or the switching inputs.

The functions are called:

- LM: Servo 1 Position 1
- LM: Servo 1 Position 2
- LM: Servo 2 Position 1
- LM: Servo 2 Position 2
- LM: Servo 3 Position 1
- LM: Servo 3 Position 2
- LM: Servo 4 Position 1
- LM: Servo 4 Position 2

Direct, proportional servo control via a prop. channel is also possible.

More information of the servo functions can be found in the operating manuals for the SFR-1, USM-RC-2, USM-RC-3 or UFR-1230 modules.

If, for example, the trailer supports are controlled via a speed controller, a interference suppression of the IR receiver and the motor cables is important. This can be done with [ferrit rings](#) (available in our shop).

Controlling the motor output

One motor can be connected directly to the light module (without an additional speed controller).

The motor can be controlled with the functions "LM: Motor up" and "LM: Motor down" with a fixed (but definable) speed.

With the modules SFR-1, USM-RC-2 and USM-RC-3, the motor can also be controlled completely proportionally via a prop. channel. Unfortunately, this is not possible with the UFR-1230.

Optionally, the motor can also be controlled manually using a switch on pin strip X5/6. The speed is set in the LM-Teacher. The standard speed is 40%. With a supply voltage of 7.2 V, this corresponds to a motor voltage of approx. 3 V, which is a suitable voltage for many trailer supports.

Green LED on LM-IR-16-4

The green LED on the LM-IR-16-4 indicates different states of the module:

LED	State
Steady light	No IR connection
Flashing regularly	IR reception is ok
3 x flashing, then 3 s pause	Overcurrent at switching outputs
4 x flashing, then 3 s pause	Motor output overcurrent

PC software „LM-Teacher“

With the software "LM-Teacher" extended options of the light module can be configured.

The software can be [downloaded](#) for free from our website.

The light module is ready for operation in the delivery state. The use of this software is therefore not absolutely necessary! The data cable [K-USB-2](#) and the LM-Teacher are only required if the extended settings are to be changed.

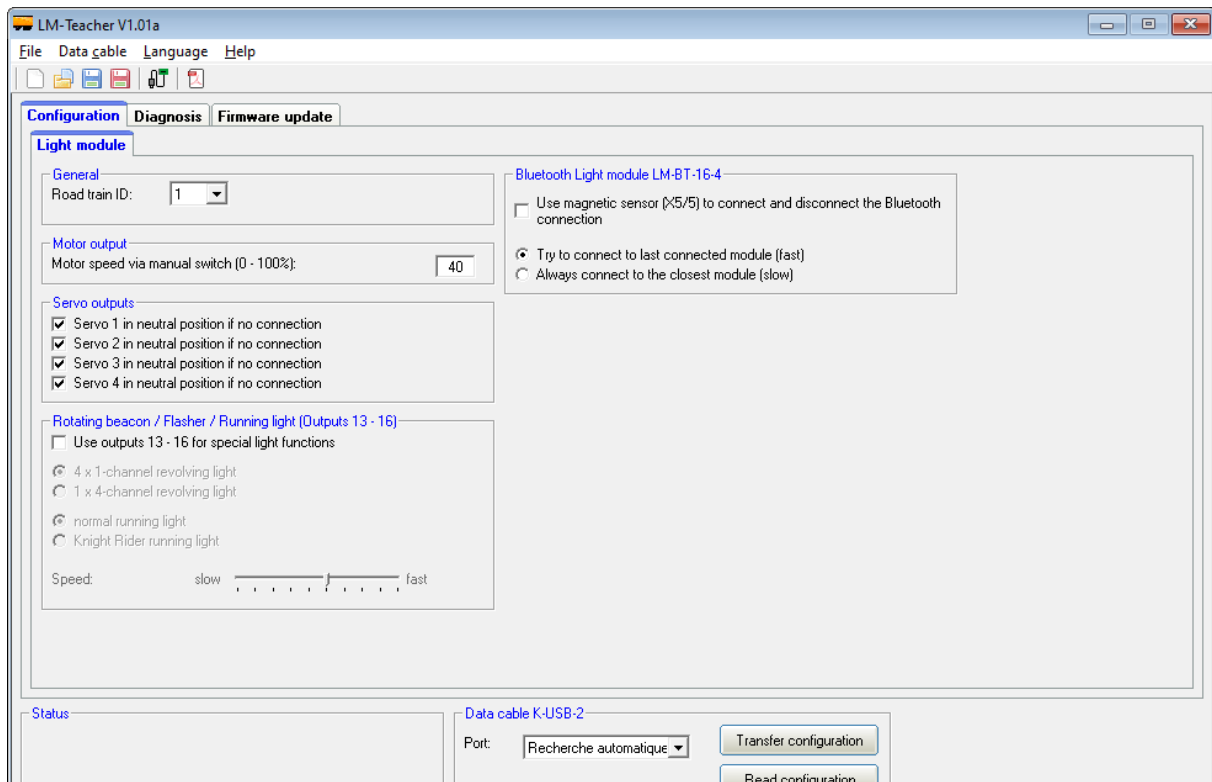

System requirements

- Windows compatible PC
- Windows 2000, NT, XP, Vista, Windows 7, Windows 8 or Windows 10
- approx. 5 MB of free HD space
- free USB port (1.0, 1.1, 2.0 or 3.0)

Software installation

After downloading the software, it must be installed on the PC. To do this, start the downloaded file and simply follow the instructions of the installation program. To start the program easily create a desktop icon.

Using software „LM-Teacher“

Menue

File	Create new project	Creates a new project
	Open project	Opens an existing project
	Save project	Saves the current project
	Save project as	Saves a copy of the current project with a new name
	Check automatically for updates	When starting the LM-Teacher, it will be checked if a new version is available
	Check now manually for updates	Checks if a new version is available
	Close	Exit the LM-Teacher
Data cable	Upload configuration to light module	Transfer of all LM-Teacher settings to light module
	Download configuration of light module	Download of all settings from light module to LM-Teacher
Language	German	Switches to German language
	English	Switches to English language
	French	Switches to French language
	Dutch	Switches to Dutch language
Help	Operating manual	Opens this manual (PDF)
	Info	Shows informations about the software

Functions

There are three areas in the LM-Teacher:

- Configuration
- Diagnosis
- Firmware update

Configuration – Light module

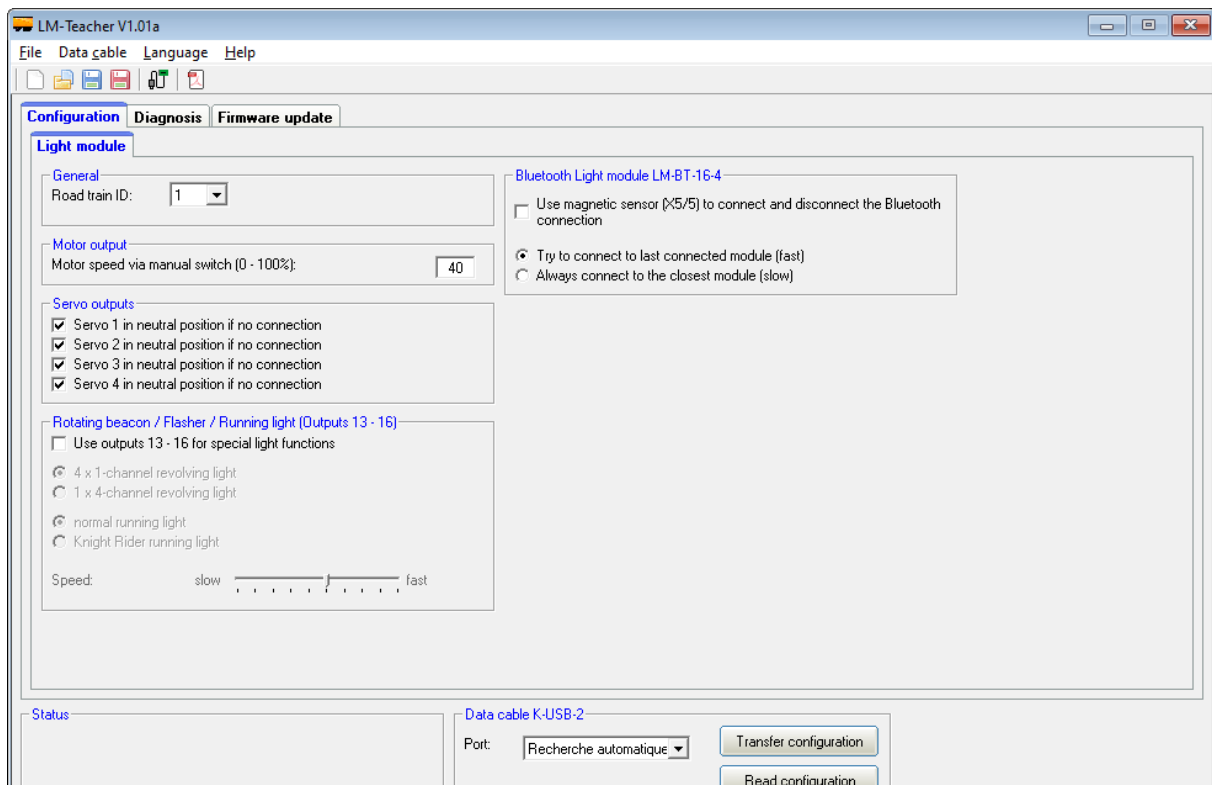

The settings in the picture show to the delivery status.

General

An ID from 1 to 7 can be assigned to each light module. With a road train, the servo outputs and the motor output can be controlled with just one module using this ID. If no road train is implemented, the ID is irrelevant.

Engine output

If the motor output is controlled via the manual switch at X5/6, the speed can be set here. 100% corresponds to the maximum speed (voltage for motor = supply voltage of the LM-IR-16-4).

If the motor should run more slowly, the speed can be reduced here. For a voltage of approx. 3 V at the motor, a speed of approx. 40% is required with a 7.2 V battery.

Servo outputs

In case there is no IR connection you can choose in this box whether the servo outputs should move to neutral position (center) or hold their last position.

All-round / flashing / running lights (Outputs 13 – 16)

If outputs 13 - 16 are to be used for the special light functions, this must be activated here.

There are two options for the all-round light, either 4 x 1-channel or 1 x 4-channel.

For the running light you can choose between a normal (runs in one direction only) and a Knight Rider running light (runs back and forth).

The speed for all three special lights can be adjusted in 10 steps.

Bluetooth Light module LM-BT-16-4

With the Bluetooth version LM-BT-16-4 of the light module, a few more options can be set here. These settings have no function for the infrared version LM-IR-16-4.

Diagnosis

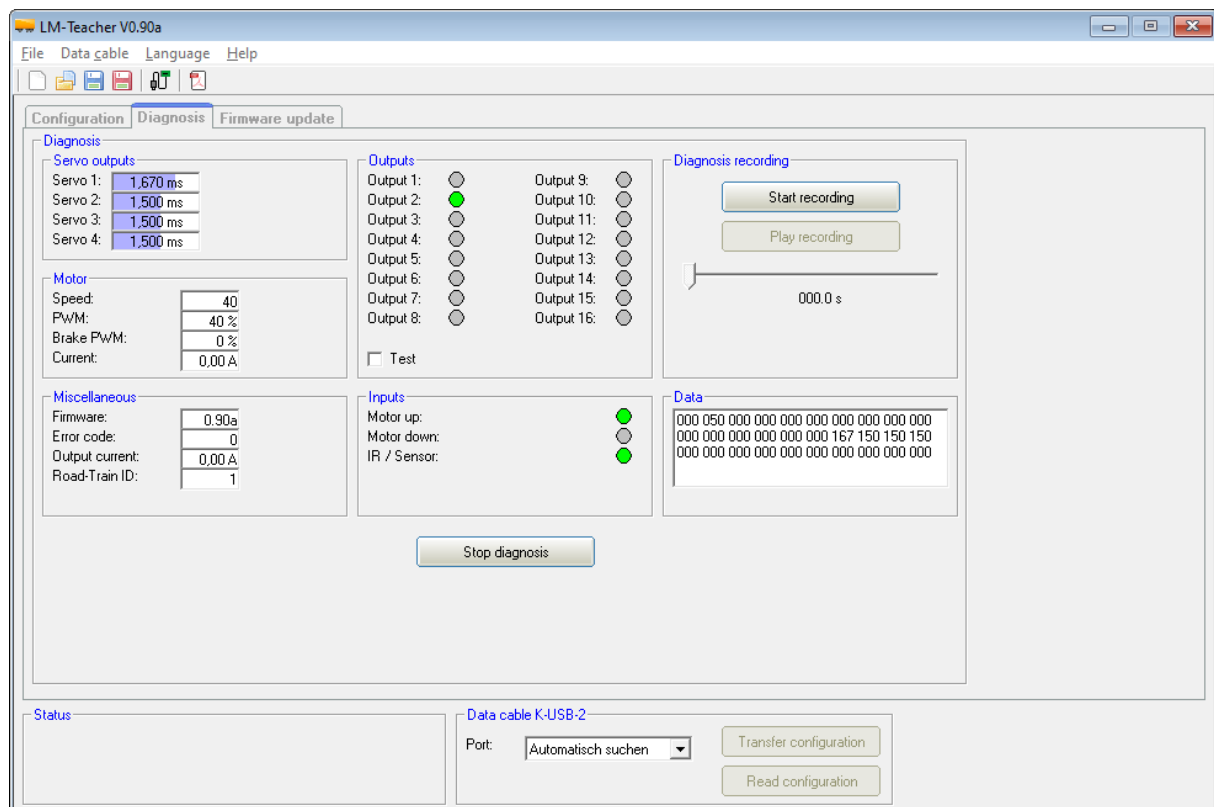

A diagnostic function is integrated in the LM-Teacher. This feature is very helpful to check the various functions of the light module. The data cable [K-USB-2](#) must be connected to X5/7 at the light module.

The diagnosis window is divided into different areas: servo outputs, motor, miscellaneous, outputs, inputs and data.

The following explains what is displayed in the different areas:

Servo outputs

The current positions of the 4 servo outputs are displayed here.

Engine

Some values of the motor output stage are displayed in this area. These are mainly used for internal testing purposes.

Miscellaneous

The values displayed here are primarily for internal testing.

Outputs

The 16 switching outputs of the light module are displayed here. If an output is switched on, this is marked by a green circle.

If "test" is activated, all 16 outputs are briefly switched on as a running light. With this, e.g. the wiring of the outputs can be tested (on the fly) without a transmitter.

Inputs

The inputs for manual motor operation and the input of the IR receiver are shown here. If the IR reception is correct, the display in the diagnosis only flickers irregularly.

Data

The values displayed here are mainly intended for internal testing purposes.

Diagnostic recording

A diagnosis can be recorded in a file on the hard disk. The light module must always be connected with the data cable during recording.

Firmware update

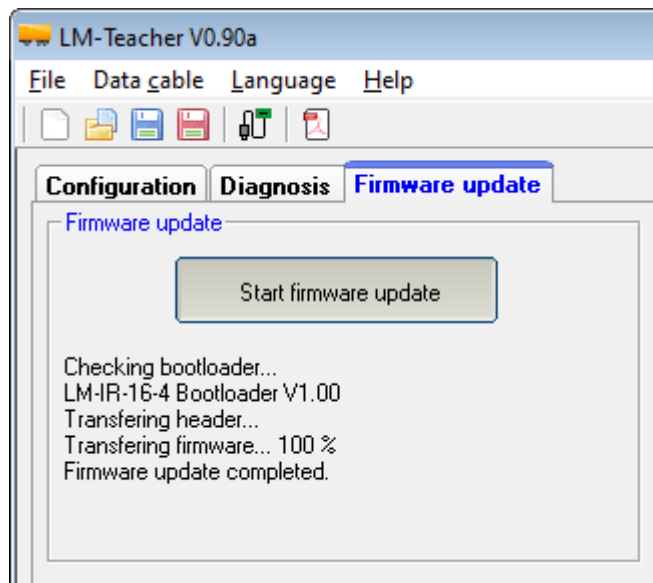

The right firmware for the light module is always integrated in the LM-Teacher. If there is an update for the LM-Teacher, a new firmware for the light module is always loaded.

The firmware update can either be started manually or the LM-Teacher receives an automatic notification as soon as new firmware is available.

The update takes about 6 seconds. The green LED flickers during the update process.

Never disconnect the module from power supply while updating!

Disposal note:

Discarded electrical and electronic equipment contains a multitude of valuable resources, including precious metals and critical raw materials. Achieving a high collection and recycling rate and the associated return of these raw materials into the production cycle is one of the central goals of the environmentally friendly and sustainable disposal of electrical and electronic equipment.

For this reason, our modules must not be disposed of with normal household waste, but must be collected separately. The communal collection points, such as recycling centers, can be used for this. Larger dealers also offer take-back points that can be used even if the product was not purchased there. We are happy to take over the professional and free disposal. To do this, send the module back to us with sufficient postage (!!!).

