

Operating Manual

Speed Controller

UFR-1230

V1.12



BEIER-Electronic
Winterbacher Str. 52/4, 73614 Schorndorf - Weiler
Phone: 07181/46232, Telefax 07181/45732
eMail: modellbau@beier-electronic.de
Internet: <http://www.beier-electronic.de/modellbau>



Contents

Contents	2
Description.....	3
Safety notes	4
Technical data	5
Pin assignment.....	6
Wiring diagram	7
Installation of speed controller.....	8
Connection of speed controller.....	8
Connection to sound module USM-RC-2	12
DIP switches.....	13
Load regulation.....	13
Cruise control	14
Brake function	14
Handbrake.....	14
Selection of battery type	15
Setup (teaching function).....	15
Driving mode	16
Additional functions	16
Control channel X3.....	18
Simulation of a control stick with switches.....	19
Nautic/Multiswitch.....	20
Switching outputs	21
Short circuit protection at motor output.....	24
Temperature monitoring	24
Low voltage monitoring.....	25
Current monitoring of outputs	25
Monitoring of proportional inputs/failsafe.....	25
LEDs on UFR-1230	26
Installation of software „UFR-1230 Drive-Teacher“	27
How to use the software „UFR-1230 Drive-Teacher“	28
Diagnosis.....	38
Firmware update.....	40

Description

The speed controller has been designed specially for RC vehicles with brushed DC motors, such as trucks.

With the various setting options the speed controller can be easily adjusted to all model requirements and driving behaviours. All settings can be adjusted with DIP switches and the software "Drive-Teacher".

The speed controller is equipped with 8 switching outputs to connect LEDs and other lights directly. In addition the speed controller has an extra output for connecting the infrared diode from the light module SM-IR-16-2.

The speed controller UFR-1230 has following characteristics:

- Supply voltage 6 – 18 V
- Maximum motor current 30 A (short-term 60 A)
- PWM pulse frequency 20 or 40 kHz
- 8 switching outputs for lights (for instance for braking, driving backwards, parking, flashing)
- Powerful BEC with 5,2 V and 3 A continuous current (short circuit proof)
- 3 proportional channels (throttle, steering, and control channel)
- 2 proportional outputs (output for sound module and steering servo)
- Additional functions (controllable with nautic and multiswitch modules)
- Failsafe in case of receiver signal disturbances (motor stop)
- Protection when switching on supply voltage
- Output for infrared diode for light module SM-IR-16-2 in trailer
- Battery voltage monitoring
- Temperatur monitoring
- Short circuit protection at motor output stage

Options adjustable with DIP switches:

- Load regulation on/off
- Cruise control on/off
- Brake function on/off
- Parking brake on/off
- Battery type: LiPo/other
- Teaching function (setup) for throttle channel on/off

Additional functions are adjustable with the software "Drive-Teacher" and can be transferred with the data cable K-USB-2 (optional available):

- Firmware update
- Diagnosis
- Inversion of channels
- Deactivation of low voltage monitoring
- Reduction of driving backwards speed to 50 %
- Selection of PWM pulse frequency between 20 or 40 kHz (for bell-armature motors)
- Adjustment of load regulation
- Activation / adjustment of inertia
- Activation / adjustment of steering inertia
- Adjustment of hand brake sensitivity
- Activation of emergency stop function
- Limitation of steering angle
- Adjustment of throttle curve
- Configuration of switching outputs (output type, brightness, Xenon effect, etc.)
- Configuration of light switch (controllable with proportional channel)
- Configuration of control channel
- Configuration of nautic / multiswitch modules
- Configuration of servo outputs of light module SM-IR-16-2

Safety notes

- Please read this operating manual carefully and keep it for future use!
- The integrated circuits on the speed controller are sensitive to electrostatic charge. Therefore it is important that you don't touch these components, before discharging yourself (e.g. through a grip onto a grounded device).
- Under certain circumstances unfavourable placement and wiring of the speed controller in the model may lead to restriction of transmitter range (mainly with 35/40 MHz transmitter).
- The speed controller should only be used with supply voltages that are given in the technical data.
- Always switch off power before connecting the speed controller!
- The speed controller is not suitable for children under 14 years.

Technical data

Supply voltage (U_b):	6 – 18 V DC
Power consumption:	Stand-by current: approx. 40 mA
Motor current:	Max. 30 A continuous current, 60 A short-term current (1 minute)
BEC voltage:	5,2 V
BEC current:	Max. 3 A continuous current, 5 A short-term current (10 seconds)
Proportional inputs:	3 pieces (1,000 – 2,000 ms): <ul style="list-style-type: none"> • Throttle channel • Steering channel • Control channel (for lights)
Proportional outputs:	2 pieces (1,000 – 2,000 ms): <ul style="list-style-type: none"> • Output for sound module • Servo output for steering servo
Switching outputs:	8 pieces (npn – open collector), max. 1,5 A per output, sum of all outputs must not exceed 3,0 A
Protection features:	<ul style="list-style-type: none"> • Short circuit protection at motor output stage • Short circuit protection at switching outputs • Short circuit protection at BEC • Temperature monitoring • Battery voltage monitoring • Protection while switching on power supply • Failsafe for proportional inputs
Additional ports:	<ul style="list-style-type: none"> • Programming interface for data cable • Port for infrared diode of light module SM-IR-16-2
Cables for connection:	<ul style="list-style-type: none"> • For battery: 2 x 2,5 mm², length approx. 15 cm (with Deans T female connector) • For Motor: 2 x 2,5 mm², length approx. 15 cm • For receiver: servo patch 3 x 0,14 mm², length approx. 30 cm
Permitted ambient temperature:	0 – 60 °C
Permitted humidity:	Max. 85 %
Size:	65 x 45 x 23 mm
Weight:	75 g

Pin assignment

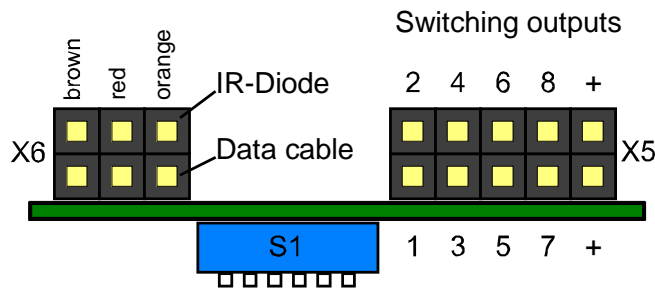
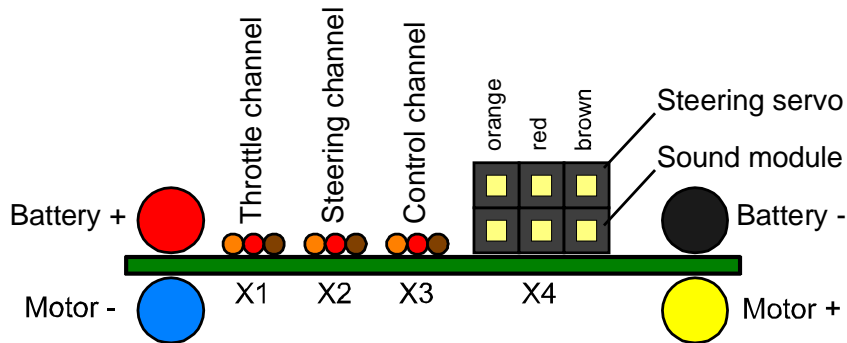
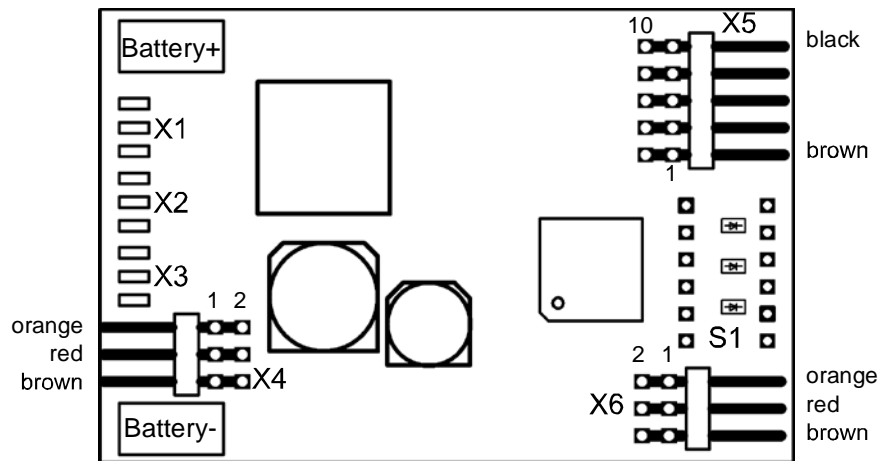

Connections at the speed controller:

Battery	red: battery +, black: battery - (Deans T female connector)
Motor	yellow: motor +, blue: motor -
X1	Proportional input: throttle channel
X2	Proportional input: steering channel
X3	Proportional input: control channel
X4/1	Proportional output: sound module
X4/2	Proportional output: steering servo
X5	Switching outputs 1 – 8
X6/1	Port for data cable K-USB-2
X6/2	Connection for infrared diode of light module SM-IR-16-2

Wiring diagram

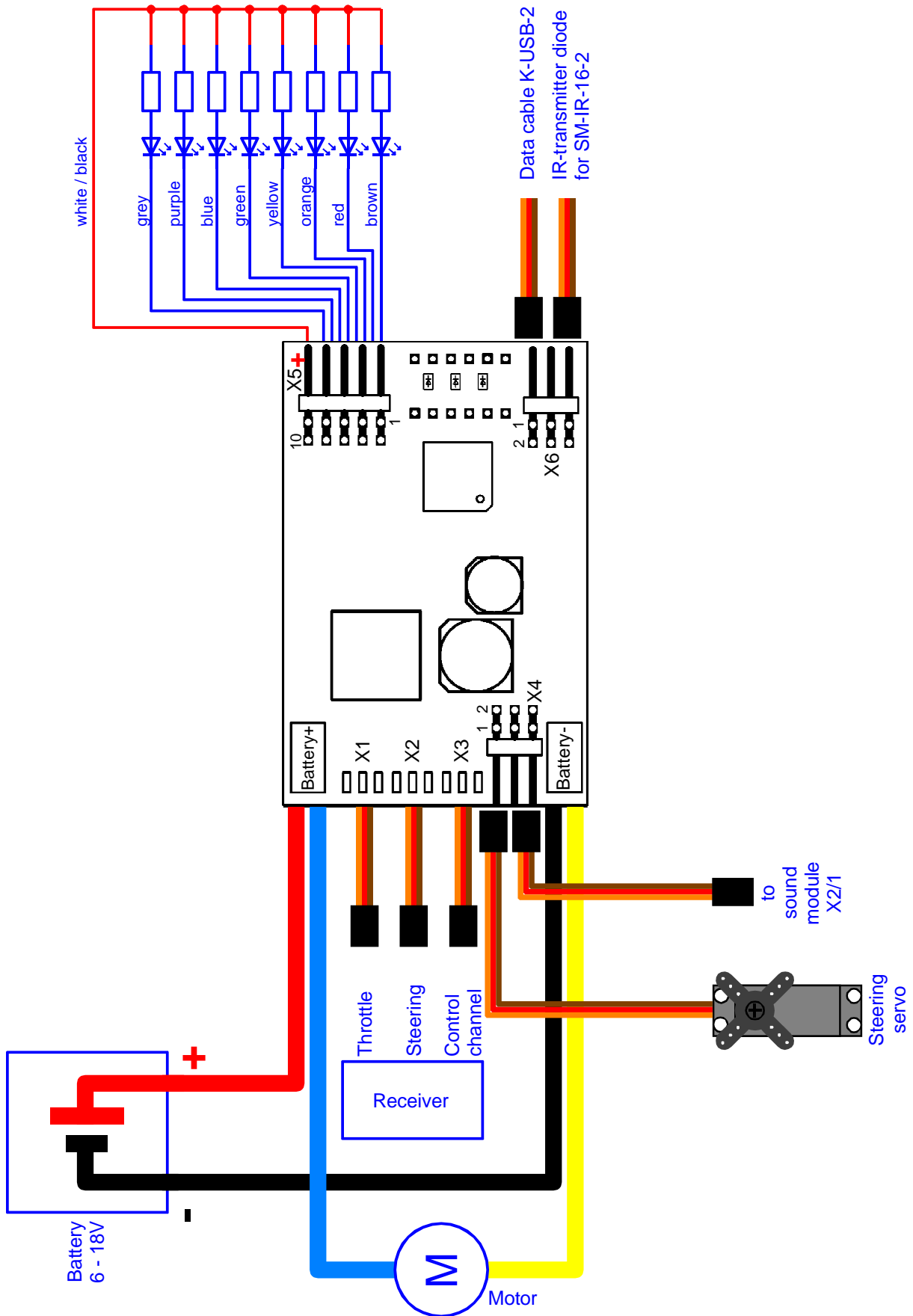

Installation of speed controller

For a safe installation of the speed controller, we recommend to use Velcro tape on the UFR-1230 cover.

Pay attention not to connect components and conductor tracks with any metal parts! This may cause a short circuit, which destroys the speed controller!

Connection of speed controller

Always switch off power before connecting the module!

Connection of supply voltage (battery):

The speed controller is suitable for 6 – 18 V DC. In order to connect the power supply the red cable is connected to the positive pole of the battery and the black cable to the negative pole of the battery.

For an easy connection, the speed controller is delivered with a Dean T female connector.

Pay attention to a correct connection of the supply voltage poles! A wrong connection destroys the speed controller immediately!!!

Connection of motor:

The yellow cable is used to connect the positive pole of a motor. The blue cable is connected to the negative pole of the motor.

In case the driving direction is wrong (forwards and backwards are opposite), you can change the connection cables of the motor or you can invert the driving direction in your Sound-Teacher, see page 29.

Connection of receiver (X1, X2 and X3):

3 servo cables (X1 - X3) are soldered to the speed controller UFR-1230, for connecting the speed controller to the receiver.

Servo cable	Channel of receiver
X1	Throttle channel
X2	Steering channel (optional for indicator lights, bending lights and steering inertia)
X3	Control channel (optional to control light functions)

Throttle channel X1 must be connected to the receiver in order to control the pace of the speed controller.

Steering channel X2 needs to be connected in case one of the following functions should be used:

- Activation of indicator lights by steering
- Automatic flashing of indicator lights while steering
- Steering inertia and steering angle limitation
- Transmission of steering signals to light module SM-IR-16-2 via infrared

Control channel X3 needs to be connected in order to trigger light functions at the speed controller, such as parking light, low/high beam and fog lights or in case the brake function (DIP switch 3) is activated (to change the driving direction).

The speed controller has its own BEC supply voltage (only with X1) an additional receiver battery is not required.

In case the BEC voltage of the UFR-1230 should not be used, the red cable from servo cable X1 and the red servo cable from X4/1 (sound module connection) must be disconnected.

Connection of sound module (X4/1)

The UFR-1230 has a special output for connecting a sound module (for example the USM-RC-2). This output X4/1 (lower pins) is connected with a servo patch cable directly to the throttle channel of the sound module (at the USM-RC-2 it is prop#1, X2/1). See page 12 for additional information.

Connection of steering servo (X4/2)

To use the steering inertia and the steering angle limitation of the UFR-1230, the steering servo must be connected to pin X4/2 (upper pins). The steering inertia needs to be activated with the software Drive-Teacher. With the data cable K-USB-2 the changed configurations can be transferred to the speed controller UFR-1230.

Without using the steering inertia and steering angle limitation the steering servo can be connected directly to the receiver.

Connection of switching outputs (X5):

To connect the switching outputs we recommend to use the supplied flat ribbon cable or the terminal clamps AKL-10/AKL-10-W. Other cables and clamps with a size 0,14mm² – 0,5mm² can be used as well.

The speed controller switches always the negative pole to the connected load. The positive pole is therefore always connected to the load, see page 7 (wiring diagram).

The joint positive pole for all outputs is at X5 on pin 9 and 10. It is also possible to connect the load directly to the positive pole of the battery.

Assignment of flat ribbon cable:

Output	Flat ribbon cable
1	brown
2	red
3	orange
4	yellow
5	green
6	blue
7	purple
8	grey
Positive pole	white
Positive pole	black

When connecting the flat ribbon cable the black cable points up to the edge of the board.

The switched voltage of the outputs (with 100 % brightness) is always as high as the supply voltage of the speed controller.

LEDs always require series resistors! Pay attention to the correct polarity. The resistor values depend on the LED colour and the LED current.

The values below are for standard LEDs with a current of 15 mA.

Supply voltage	Series resistor
6 V	270 Ohm
7,2 V	330 Ohm
8,4 V	470 Ohm
9,6 V	510 Ohm
12 V	680 Ohm
14 V	820 Ohm
16 V	1 kOhm

For an exact calculation you can use a resistor calculator, like www.leds.de/widerstandsrechner.

If more LEDs should be connected to one output (indicator front and back) it is better to use for each LED its own resistor. A series connection should be avoided.

General remarks for wiring:

Always use cables with a core diameter of at least 2,5 mm² for connecting the power supply and the motor. For all other connections, such as lights you can use smaller cables such as 0.25 mm².

Unfortunately motors are often strong interference sources, which could disturb other electronic modules in your model. Therefore all motors should be absolutely interference-suppressed!

It is important to pay attention to „clean" wire routing. Always use short wires and avoid any unnecessary loops. The supply voltage wires of the speed controller should be connected to the driving-battery as direct as possible.

A separate installation of interfering cables (for example motor cables) can achieve significant improvements.

Connection of infrared (transmitter) diode of light module SM-IR-16-2 (X6/1)

At pin X6/1 (upper pins) the transmitter infrared diode for the light module SM-IR-16-2 is connected.

All 8 outputs/light signals are transmitted 1:1 from the speed controller to the light module. The outputs 9 – 12 and the light functions (rotating, flashing and lightning lights) at output 13 – 16 of the SM-IR-16-2 can be switched with the control channel X3.

The servo outputs can be controlled by steering (for steerable axles at the trailer) or by fix (programmed) positions.

The light module SM-IR-16-2 can be connected either to the sound module USM-RC-2 or to the speed controller UFR-1230.

Connection of data cable K-USB-2 (X6/2)

The data cable K-USB-2 is connected to X6/2 (lower pins).

Following functions require a data cable:

- Transmission of Drive-Teacher configurations
- Read-out configurations of speed controller
- Run diagnosis functions
- Update of firmware

The speed controller is not powered by the data cable. For using the data cable, the UFR-1230 must be supplied with power via the battery as normal.

Connection to sound module USM-RC-2

In combination with the sound module USM-RC-2, the throttle channel from the receiver is connected directly to the speed controller (X1). The sound module (prop #1, X2/1) is connected with a servo patch cable to X4/1 (lower pins) of the speed controller and receives information through this connection.

The sound module receives the actual speed information directly from the speed controller, even if the cruise control and the load regulation are active. The sound module is operated in digital mode.

Despite using the UFR-1230 brake function, the option „speed controller has a braking feature“ must be deactivated in the USM-RC-2 Sound-Teacher (configuration - engine sound).

Digital transmission to sound module

With the Drive-Teacher software V1.10 and higher versions, it is possible to transfer speed and light data digital to the sound module USM-RC-2. The connection from X4/1 (speed controller) to X2/1(USM-RC-2) is used in combination with the activation of the digital communication in the Drive-Teacher (Configuration → Speed Controller → Other → Digital communication with sound module), see more information on page 29.

The digital communication offers several advantages:

- The zero point (driving diagram) is always correct
- More precise transfer of speed data
- Additional outputs from the USM-RC-2 can be used for connecting lights, in case the 8 light outputs at the UFR-1230 are not enough. For this, only the types for the outputs must be selected in the Sound-Teacher. This works with these light functions:
 - Daytime running light
 - Parking light
 - Low beam headlight
 - High beam headlight
 - Indicator left / right
 - Bending light left / right
 - Fog light
 - Rear fog light
 - Brake light
 - Reversing light
- The sound module monitors all functions of the UFR-1230. For example, if the speed controller is flashing the sound module activates the corresponding indicator sound automatically
- No additional wiring is necessary in order to transfer light signals from the UFR-1230 to the sound module and further to the IR-light module SM-IR-16-2.

For digital communication at least Sound-Teacher V1.50 is required. You also need to activate „Digital mode with UFR ESC“ in your Sound-Teacher (Configuration → General → General → Module configuration).

DIP switches

Following functions can be activated and deactivated with the DIP switches:

Switch	OFF	ON
1	Load regulation off	Load regulation on
2	Cruise control off	Cruise control on
3	Brake function off	Brake function on
4	Handbrake off	Handbrake on
5	Other type of battery	LiPo Battery
6	Normal driving	Setup (teaching) on

All DIP switches can be changed during driving, except of switch 5, which must be used before turning on power supply.

Load regulation

With DIP switch 1 an optional load regulation can be activated. The speed controller will check the current driving speed in case the throttle channel position differs from the actual driving speed due to environmental impacts and will maintain the driving speed.

For example a model starts to drive up a hill, this requires more throttle to keep the pace. With the activated load regulation the throttle adjustment is automatically done by the speed controller when driving up or down a hill.

This effect is particularly visible at a slow/medium driving speed. However, at a very slow speed the load regulation may reach its limits.

How fast the load regulation should adjust the speed can be set in the Drive-Teacher.

Depending on the motor the load regulation effect may vary. This function is still in „development stage“ and we can not guarantee a perfect performance with all motor types.

The load regulation can also be activated/deactivated (temporarily) with an additional function (control channel X3). The dip switch 1 position indicates the standard setting of the load regulation.

Cruise control

With DIP switch 2 the cruise control can be activated (ON).

With activated cruise control the throttle position controls not any longer the actual driving speed but the change in speed. In neutral position (throttle stick) the cruise control keeps the speed.

The speed increases when pressing up the throttle stick and decreases (until standing) when pressing down.

While driving backwards the handling is the same (just opposite). The model accelerates when the throttle stick is put down and slows down when it is put up.

The further the throttle stick is moved away from neutral, the stronger the speed controller accelerates or decelerates.

With activated brake function (DIP switch 3 ON) the throttle stick must be moved up for acceleration even when driving backwards. Control channel X3 must be used to put in the reverse gear.

The cruise control can also be activated/deactivated (temporarily) with an additional function (control channel X3). The dip switch 2 position indicates the standard setting.

Brake function

With the brake function (DIP switch 3 ON) the vehicle can be slowed down by the speed controller UFR-1230.

The stronger the throttle stick is pressed down, the stronger the vehicle brakes.

To drive backwards the driving direction must be changes with the control channel X3. To accelerate backwards (in reverse gear) the throttle stick must be pressed up.

Handbrake

With activated handbrake (DIP switch 4 ON) the vehicle is stopped by the EMF motor brake to prevent a roll away.

When accelerating, the handbrake is deactivated automatically. In the Drive-Teacher you can set the handbrake hardness and wether it should be activated only while standing or as soon as the throttle channel is in neutral position and the vehicle is still rolling out.

However, the EMF brake is not as effective as a mechanical brake. At a steep incline the vehicle may roll away despite the handbrake.

Selection of battery type

With a LiPo battery DIP switch 5 must be set ON. With all other types of batteries the switch is OFF.

The battery setting is important for a correct low voltage monitoring (see page 25).

Setup (teaching function)

With the teaching function important parameters can be synchronised between the radio and the speed controller, such as:

- Neutral position of throttle channel X1
- Neutral position steering channel X2
- Neutral position of control channel X3
- Maximum position of throttle channel X1
- Minimal position of throttle channel X1

The speed controller is delivered with following standard setting: neutral position (1,5 ms), minimal position (1,0 ms) and maximal position (2,0 ms).

We recommend to „teach“ the speed controller with the radio at least once. The motor is not triggered during teaching, except of the peeper in step 4, 5 and 6.

1. Connect throttle channel X1, steering channel X2 and control channel X3 to your receiver.
2. All channels must be in neutral position. Turn on receiver.
3. Put **DIP switch 6** to **ON**.
4. Turn on supply voltage at speed controller → the green LED is flashing fast. If there is a good signal at throttle channel X1 the neutral position of the throttle stick is saved. If the red LED is flashing, the speed controller can not detect a correct signal at X1. Please check all connections again.
5. For a short while give full throttle and press the stick all the way up. Return to neutral position → the blue LED flashes two times and lights permanently afterwards.
6. For 10 seconds press the throttle stick down and give full throttle backwards and return to neutral position → the blue LED flashes three times. The green LED lights permanently afterwards.
7. The setup is completed. Turn the **DIP switch 6 OFF**.

Driving mode

There are 4 driving modes, combining the functions cruise control and braking.

Depending on the driving mode the throttle channel is used differently:

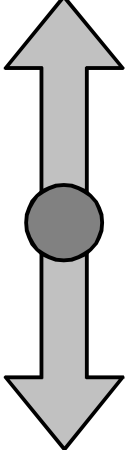
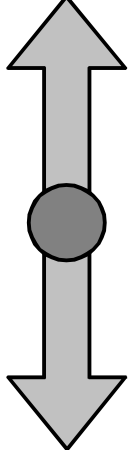
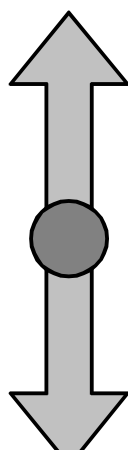
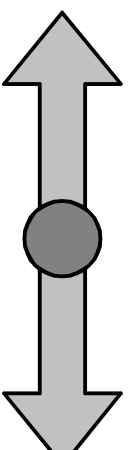
No cruise control No brake function	No cruise control with brake	with cruise control no brake function	with cruise control with brake
<p>driving forwards</p>  <p>driving backwards</p>	<p>driving forwards and backwards</p>  <p>braking</p>	<p>forwards accelerating / backwards slowing down</p>  <p>forwards slowing down / backwards accelerating</p>	<p>forwards and backwards accelerating</p>  <p>slowing down and braking</p>
DIP switch 2: OFF DIP switch 3: OFF	DIP switch 2: OFF DIP switch 3: ON	DIP switch 2: ON DIP switch 3: OFF	DIP switch 2: ON DIP switch 3: ON

With activated braking function (DIP switch 3 ON) the driving direction must be changed by control channel X3.

It is not always practical to drive backwards using the cruise control.

For this reason, it is possible to turn off the cruise control automatically while driving backward. By selecting the option the cruise control is only active while driving forwards.

Additional functions

Following additional functions can be triggered with control channel X3:

- Triggering outputs 1 – 8 static
- Daytime running light
- Low beam headlight
- High beam headlight
- Fog light

- Rear fog light
- Indicator left
- Indicator right
- Hazard light
- Light switch +
- Light switch -
- Changing driving direction
- Changing to throttle curve 2
- Load regulation on/off
- Cruise control on/off
- Inertia off
- Inertia light
- Inertia medium
- Inertia heavy
- Steering limit off
- SM-IR-16-2: servo 1 - position #1
- SM-IR-16-2: servo 1 - position #2
- SM-IR-16-2: servo 2 - position #1
- SM-IR-16-2: servo 2 - position #2
- SM-IR-16-2: output 9
- SM-IR-16-2: output 10
- SM-IR-16-2: output 11
- SM-IR-16-2: output 12
- SM-IR-16-2: rotating light
- SM-IR-16-2: flasher
- SM-IR-16-2: running light
- Flash

With a normal proportional channel a maximum of 8 functions can be triggered (see page 32).

To trigger more additional functions we recommend to use a radio with nautic / multiswitch module.

With the function „output 1 – 8“ the outputs are always switched as static (on/off), independent from the defined output type. Flashing lights, such as indicators must be switched with the specific light function „indicator left“ and „indicator right“ and not by „output 1 – 8“.

The outputs 9 – 12 of the light module SM-IR-16-2 can only be switched as static with a light intensity of 100 %. An adjustment or change is not possible.

Control channel X3

With control channel X3 lights and other additional functions can be switched (see page 16). With the activated option „brake function“ (DIP switch 3) the driving direction must be changed with control channel X3.

A proportional channel is divided in 5 areas, namely A, B, N, C and D, which indicate the possible control stick positions.

Area N is the middle position and therefore neutral with no function.

Area A is on the left and D on the right side. Some radios have an opposite division. In this case the channel must be inverted at the radio or with the Drive-Teacher to trigger functions (left/right indicator) correctly.

Standard setting of control channel X3:

	A	B	N	C	D
Short in position	Indicator left on/off				Indicator right on/off
Long in position	Light switch -	Change driving direction		Hazard light on/off	Light switch +

The assignment of functions can be changed with the Drive-Teacher (see page 32).

If the function „automatic indicator lights while turning“ is activated in the Drive-Teacher the indicator lights can only be activated with the steering channel (X2) and no longer with the control channel (X3)!

The driving direction can only be changed while standing.

Simulation of a control stick with switches

In most cases the control sticks of a radio are occupied with other functions. Therefore you need a different option to control the functions of channel X3.

With one free channel and two switches the different positions of a poti / control stick can be simulated. You can find the circuit plan on the right. Example: if you press switch S1 position A of a control stick is simulated and the programmed function (light) is activated or deactivated.

For this setting you need 6 resistors and 4 switches (or 2 switches with neutral position). You can build the circuit easily on a board in a short time.

The resistor values should be sufficient for the most commercially sold radios. The 5 thresholds can be adjusted with the Drive-Teacher.

Depending on your radio type the circuit as well as the installation might be different.

With some radios (Futaba/Robbe) you might need one additional 68k Ohm resistor for neutral „S“.

Hint:

The correct function can be checked with the diagnosis function of the Drive-Teacher.

You can also buy „ready to use“ switch modules in our online shop. For Robbe radios we recommend switch SMS-R and for all other types of radios SMS-G.

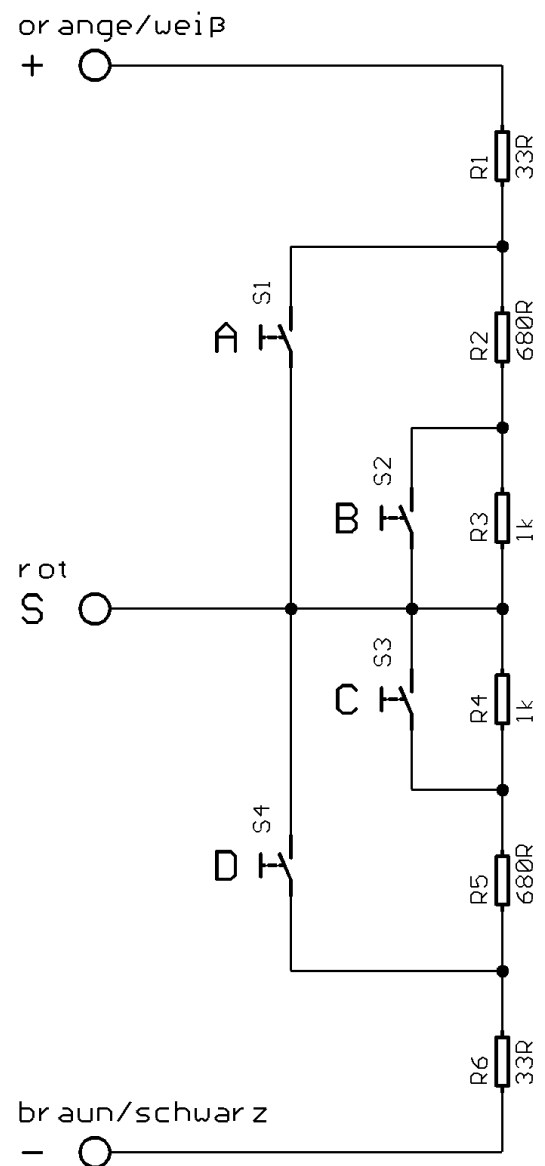

Nautic/Multiswitch

All additional functions of the UFR-1230-D can be controlled with nautic and multiswitch modules.

Following switch modules can be used with the speed controller UFR-1230:

- BEIER-Electronic NMS-16-R, NMS-16-G and NMS-24-G
- BEIER-Electronic EMS-16-R, EMS-16-G and EMS-24-G
- BEIER-Electronic MSC-8-C, MSC-10-C and MSC-8-C-LCD
- Graupner Nautic-Expert Module (Nr. 4108), Multikanal
- Robbe Multi-Switch Module (Nr. 8084, 8101, 8413, F1511)
- Mergen/CP 12-Channel and 16-Channel Multiswitch

Some of the new radio types have „software-nautic-switches“ which might be used as well. For more information please check the operating manual of your radio.

To use the nautic mode the option must be activated in the Drive-Teacher.

For each switch position additional functions (see page 16) can be set in the Drive-Teacher (see page 32). When pressing the switch the assigned function is activated.

With the option „memory“ the function stays activated until the switch is pressed again.

To use a nautic/multiswitch module the servo channel X3 of the UFR-1230 must be connected to the correct receiver output (corresponding to the used transmitter input).

If the UFR-1230 receives correct data from the nautic/multiswitch module, the blue LED flashes regularly in short intervalls. With EMS modules the blue LED only lights as long as one of the switches is pressed.

If the blue LED is not flashing regularly or the nautic/multiswitch module is not working properly, please check the settings at your radio. In the operating manual of your radio you can read more about the required settings for a nautic module.

At radios with Jeti Duplex 2,4 GHz the „output period“ of the receiver must be set with the Jeti-Box to „by transmitter“ or „auto“. Further important settings are: ATV high limit: 2,20 ms, ATV low limit: 0,80 ms.

Switching outputs

The UFR-1230 switching outputs can be used for connecting LEDs and other lights.

The UFR-1230 is delivered with following output setting:

Output	Type
1	Brake light
2	Reversing light
3	Parking light
4	Low beam headlight
5	Indicator left
6	Indicator right
7	Bending light left
8	Bending light right

With the software Drive-Teacher and the data cable K-USB-2 all settings can be changed. Following output types are available:

- Daytime running light
- Parking light
- Low beam headlight
- High beam headlight
- Indicator left
- Indicator right
- Bending light left (fog light)
- Bending light right (fog light)
- Fog light
- Rear fog light
- Brake light
- Reversing light
- Combined headlight
- Combined rear light
- Combined American rear light left
- Combined American rear light right
- In stationary on
- In motion on
- Temperature controlled

All outputs are minus switching, which means the negative pole is always switched to the connected load (for example to LEDs, lights, relais etc.). The positive pole of the supply voltage is connected directly to each load.

The light intensity (PWM control) of each output can be set in 2 % steps between 2 % and 100 %.

Optionally, an incandescent effect can be activated for each output. This behaves an LED when switching on and off, then like a light bulb.

Output „daytime running light“, „parking light“, „low beam headlight“, „high beam headlight“, „fog light“ and „rear fog light“

These outputs are activated, as soon as the light switch is in a step, where these lights are programmed. Alternatively, these outputs can also be switched by their "names" independent from the light switch settings.

The labels for the lights are not binding. You can connect and trigger all kind of lights to these outputs.

Output „reversing light“

The output for reversing light is always activated as soon as the reverse gear is activated or the model is driving backwards.

Output „brake light“

The brake light is always activated for a short time as soon as the model slows down. For a realistic effect the light duration depends on the brake intensity.

Output „indicator left“ and „indicator right“

The indicator outputs can be switched with control channel X3 (see page 18).

The indicators are always switched off automatically with the steering channel X2. For example after turning right the indicator is deactivated as soon as the steering channel X2 is in neutral position again.

Alternatively, it is possible to activate the indicator lights automatically while turning (see page 34).

If the option „American indicator mode“ is activated, the indicator LEDs light permanently as long as the „parking light“ is switched on. The light intensity for this indicator-parking-light can be set with „**Option 1**“ (for example 10 %) in the Drive-Teacher.

For hazard lights both indicators flash simultaneously.

Output „bending light left“ and „bending light right“

These outputs can be activated while turning. The lights are activated/deactivated with a dimming effect.

There are two options to switch bending lights:

1. With steering channel X2
2. With indicator lights

For more information see page 35.

The bending lights only work, when the parking or low beam lights are also switched on! To use the bending lights as fog lights activate the function „using bending lights as fog lights“. Furthermore both bending lights can be activated when driving backwards.

Output „combined headlight“

Using the combined headlight the lights „parking light“, „low beam headlight“ and „high beam headlight“ can be switched with only one output (with the same LED).

For each of the 3 lights a separate light intensity can be set:

The parking light intensity at „**Intensity**“ (e.g. 10 %).

The low beam headlight intensity at „**Option 1**“ (e.g. 30 %).

The high beam headlight intensity at „**Option 2**“ (e.g. 60 %).

The 3 intensities are added when more lights are activated at the same time. The sum should not be over 100 % in total.

Output „combined rear light“

Using the combined rear light the lights „parking light“, „brake light“ and „rear fog light“ can be switched with only one output (with the same LED).

For each of the 3 lights a separate light intensity can be set:

The parking light intensity at „**Intensity**“ (e.g. 10 %).

The brake light intensity at „**Option 1**“ (e.g. 40 %).

The rear fog light intensity at „**Option 2**“ (e.g. 50 %).

The 3 intensities are added when more lights are activated at the same time. The sum should not be over 100 % in total.

Output „combined American rear light left/right“

The 3 light functions „parking light“, „brake light“ and „indicator left/ right“ can be switched with only one output.

For each of the 3 lights a separate light intensity can be set:

The parking light intensity at „**Intensity**“ (e.g. 10 %).

The brake light intensity at „**Option 1**“ (e.g. 100 %).

The indicator light intensity at „**Option 2**“ (e.g. 50 %).

In comparison to the other lights, the intensities are not added.

Output „In stationary on“

As soon as the model is standing, this output is activated.

Output „In motion on“

As long as the model is moving, the output is activated. The direction of the movement does not matter.

Output „Temperature controlled“

By using the temperature sensor on the board of the UFR-1230 you can control an additional fan, in order to cool the motor output stage. In configuration you can set the temperatures at which the fan should be activated and deactivated.

Flasher

In addition to their set type, the outputs can also be assigned to 6 different types of flashers. If the flasher is activated, the output will flash according to the set flasher type. While the flasher is on, the normal function of the output is disabled. Several types of flashers can also be assigned to one output at the same time.

The flashers are all activated with the function "Flash", via the control channel X3, (or Nautic/Multiswitch).

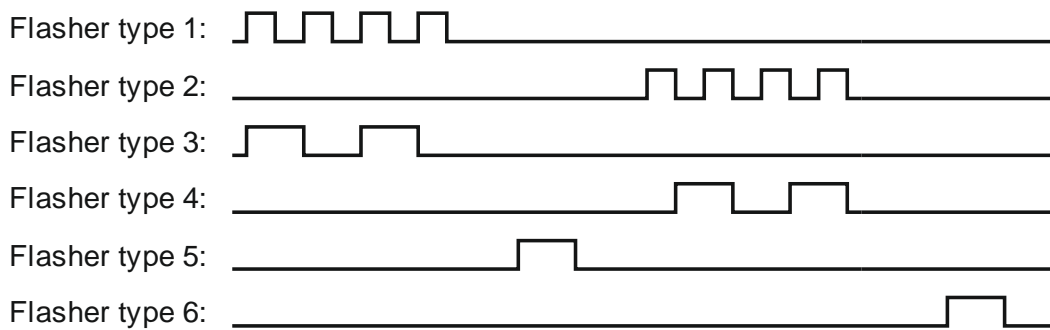

Short circuit protection at motor output

If a short circuit at the motor output is detected, following actions are carried out:

- Motor stop
- Fast flashing of braking lights (you can change the flashing output with your Drive-Teacher, see page 34)
- Flashing of red LED on the UFR-1230

Temperature monitoring

The UFR-1230 contains an integrated sensor to monitor permanently the temperature. If the measured temperature exceeds 80 °C following actions are executed:

- Reduction of driving speed to maximum 30 %
- Slowly flashing of braking lights (you can change the output with your Drive-Teacher, see page 34)
- Slowly flashing of red LED on the UFR-1230

Low voltage monitoring

LiPo batteries must not be discharged too deeply to avoid damages. Therefore the speed controller monitors permanently the battery voltage. If this value is below a certain threshold (3,2 V per cell with LiPo, 1,0 V per cell with NiCd and NiCd) following actions are executed:

- Reduction of driving speed to maximum 30 %
- Slowly flashing of reversing lights (you can change the output with your Drive-Teacher, see page 34)
- Slowly flashing of the blue LED on the UFR-1230

When connecting a LiPo-, NiMh- or NiCd battery the speed controller recognizes the number of cells automatically. For the correct detection of cells, the battery must not be (almost) empty. When turning on the supply voltage a signal tone beeps for each cell. For example with a 2S LiPo the speed controller beeps twice and with a 3S LiPo three times.

With the Drive-Teacher the low voltage monitoring can be deactivated, which might be necessary with some types of batteries.

Current monitoring of outputs

The 8 switching outputs are monitored continuously. In case of a detected current overload all 8 outputs are deactivated.

This current monitoring is no 100 % short circuit protection! It is important to avoid short circuits when connecting the outputs.

If an overcurrent is detected following actions are executed:

- Deactivation of all outputs
- The red LED on the speed controller lights permanently

Monitoring of proportional inputs/failsafe

The signals of proportional channel X1, X2 and X3 are monitored permanently by the speed controller.

In case no correct signal is received at the throttle channel X1 the speed controller stops due to safety reasons and the blue LED lights permanently at the speed controller.

To avoid a sudden „start“ when connecting the supply voltage the throttle channel must be in neutral position in order to control the motor. The green LED flashes slowly as long as the throttle channel was not in neutral position.

LEDs on UFR-1230

The speed controller has 3 LEDs to indicate the different states.

State/Problem	green LED	red LED	blue LED
Ready for operation	on		
Throttle has not been in neutral position yet	slow flashing		
Active teaching function	fast flashing		
Overcurrent at switching outputs		on	
High temperature		slow flashing	
Overcurrent at motor output stage		fast flashing	
No signal at throttle channel			on
Low voltage			slow flashing
Nautic-/multiswitch signal detected correctly			fast flashing

Installation of software „UFR-1230 Drive-Teacher“

Additional options can be set at the speed controller with the Windows-based software „UFR-1230 Drive-Teacher“.

A free download of the software is available on our website.

At delivery the speed controller is ready for use. Therefore the software is only necessary when adjustments from the standard setting should be done. The data cable K-USB-2 is required to transfer the new configuration.

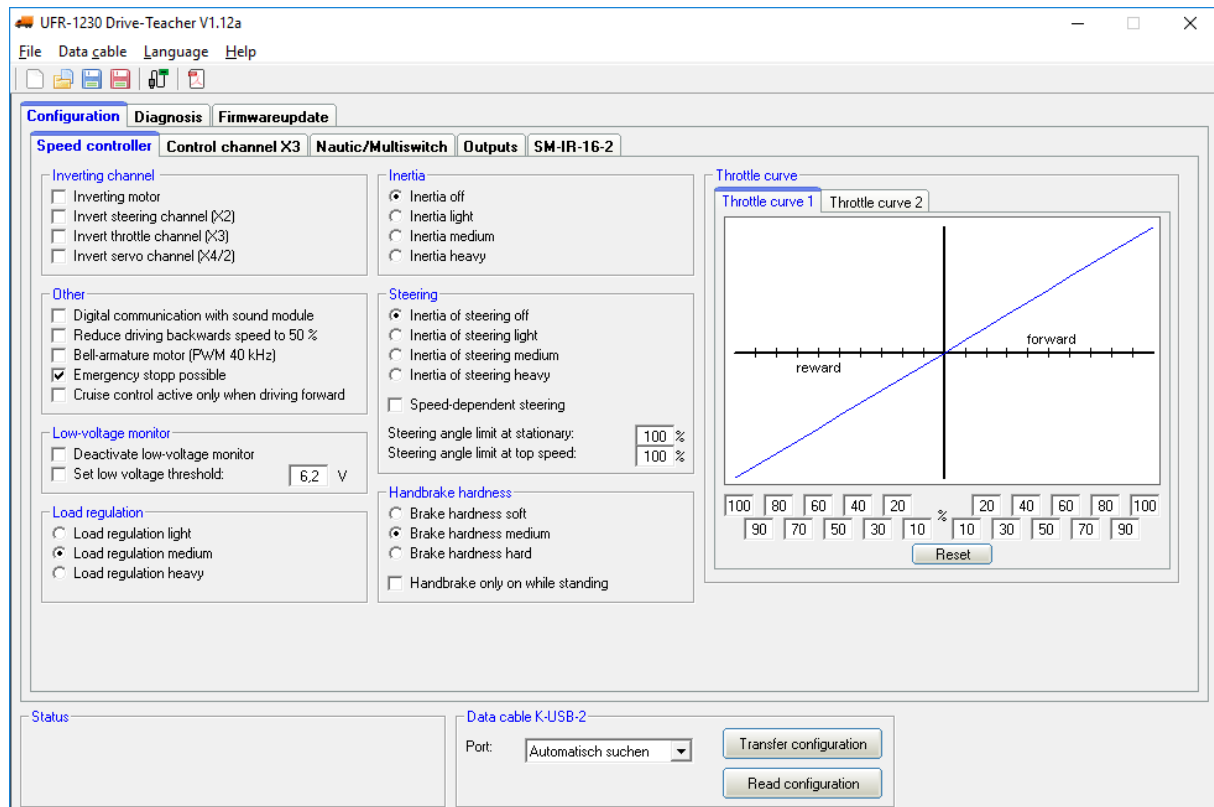

System requirements

- Windows compatible computer
- Windows 2000, NT, XP, Vista, Windows 7, Windows 8 or Windows 10
- approx. 5 MB free hard disk drive
- free USB port (1.0, 1.1, 2.0 or 3.0)

Installation of software

After download, the software must be installed on the computer. Just start the downloaded program and follow the instructions. Do not forget to activate the desktop icon.

How to use the software „UFR-1230 Drive-Teacher“

Menüs

File	Create new project	Creates a new project
	Open project	Opens an existing project
	Save project	Saves the current project
	Save project as	Saves a copy of the current project with a new name
	Upload project data via datacable	Uploads the complete project data via datacable to the sound module
	Check automatically for updates	On every start of the Sound-Teacher, it will be checked if a new version is available
	Check now manually for updates	Checks if a new version is available
	Close	Closes the program
Data cable	Upload configuration to UFR-1230	Transfers the current settings to the speed controller
	Download configuration from UFR-1230	Reads out the settings from the speed controller
	Reset throttle channel setup	Resets the setup values from gas channel X1 to the factory settings. Also, the neutral positions of X2 and X3 are reset
Language	German	Switches to german language
	English	Switches to english language
	French	Switches to french language
Help	Manual	Opens this manual
	Info	Shows informations about the software

Functions

The Drive-Teacher is separated in 3 sections:

- Configuration
- Diagnosis
- Firmwareupdate

The section configuration has 5 subdivisions:

- Speed controller
- Throttle channel X3
- Nautic/Multiswitch
- Outputs
- Light module SM-IR-16-2

Configuration – speed controller

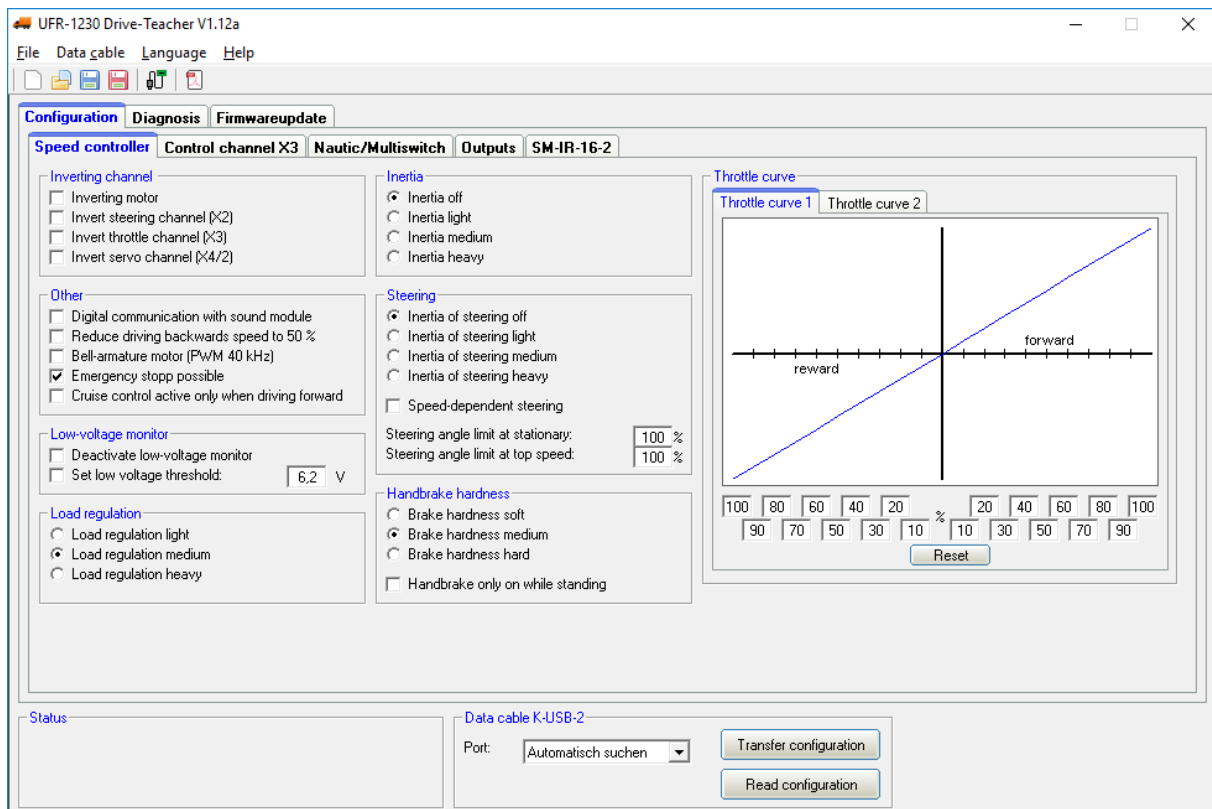

The picture shows the standard settings at delivery.

Invert channel

In case the motor is running in the opposite direction (backwards instead of forwards) it can be inverted here.

All proportional channels of steering channel (X2), control channel (X3) and the direction of a steering servo (X4/2) can be reversed. Right and left are turned when the option is activated.

Low voltage monitoring

Low voltage monitoring can be deactivated and adapted here.

The Low voltage threshold can be set between 5,5 V and 16,0 V. If no value is manually set, the threshold is automatically set corresponding to the used battery type, see page 25.

Other

Using digital communication all speed and light data are transferred from speed controller UFR-1230 to sound module USM-RC-2 with only one connection at X4/1, see page 12 for more information. In your Drive-Teacher the settings „Digital communication with sound module“ and in your Sound-Teacher „Digital mode with UFR ESC“ must be activated.

The driving backwards speed can be reduced to 50 %.

When using a bell-armature motor, this motor type should be activated in the Drive-Teacher. The PWM pulse frequency is increased to 40 kHz to protect the motor.

With the function „Emergency stop possible“, the model can quickly be stopped by a complete pressing down of the gas throttle. Other settings, such as cruise control, brake funktion, load regulation, hand brake, inertia etc. have no effect on this function. The emergency stop is always given priority.

By selecting the option „Cruise control only active when driving forward“ the cruise control is automatically switched off when driving backwards.

Load regulation

With activated load regulation (see page 13) one of the different regulation intensities (light, medium and heavy) can be set here.

Inertia

To simulate a very heavy vehicle the option mass inertia can be activated here. Acceleration and decelaration are slowed down for a realistic driving behaviour. Keep in mind: the vehicle also has a longer stopping distance!

With control chanel X3 the different intensities of inertia can be activated and deactivated using additional functions. The setting in the speed controller with the Drive-Teacher is the standard setting when turning on the model.

Inertia of steering

For a realistic steering behaviour a inertia while steering can be activated as well. For this effect the steering servo must be connected to proportional channel X4/2.

There is also an option for a speed dependent steering inertia:

- While parking: high inertia
- Slow driving: low inertia
- Medium drive: medium inertia
- Fast drive: high inertia

With the parameters „Steering angle limit at stationary“ and „Steering angle limit at top speed“ the steering angle can be optimized. Values between 30 % and 120 % can be set. The smaller the value, the smaller the steering angle. Values higher than 100 % make the steering angle larger. It is important to check first, if the steering servo is suitable for large angles.

When driving between stationary and full throttle the UFR-1230 calculates the corresponding steering angle within the set max/min values.

If no limits are manually set, the standard values are 100 %.

The application of steering angle limitation is quite useful, in case there is no option to limit the angle directly at the radio.

Furthermore this function enables to use a different range of steering for manoeuvring and for normal (fast) driving. During manoeuvring the full range is

useful whereas at high speed a smaller steering range enables a more sensitive steering.

Hardness of handbrake

If the function handbrake is activated with DIP switch 4 the hardness of braking can be set here.

The handbrake can only be active while parking/standing. Without this option, the handbrake hits as soon as the throttle is in neutral position and the vehicle is still rolling.

Throttle curve 1 and 2

Using the curve, the proportion between throttle signal and driving behaviour can be set in the diagram. Both driving directions (backwards and forwards) have 10 values (at 10 %, 20 %, 30 %, 40 %, 50 %, 60 %, 70 %, 80 %, 90 % and 100 % of throttle signal) to adjust the driving behaviour.

For example a very sensitive acceleration behaviour for driving slowly or a limited maximum speed can be set.

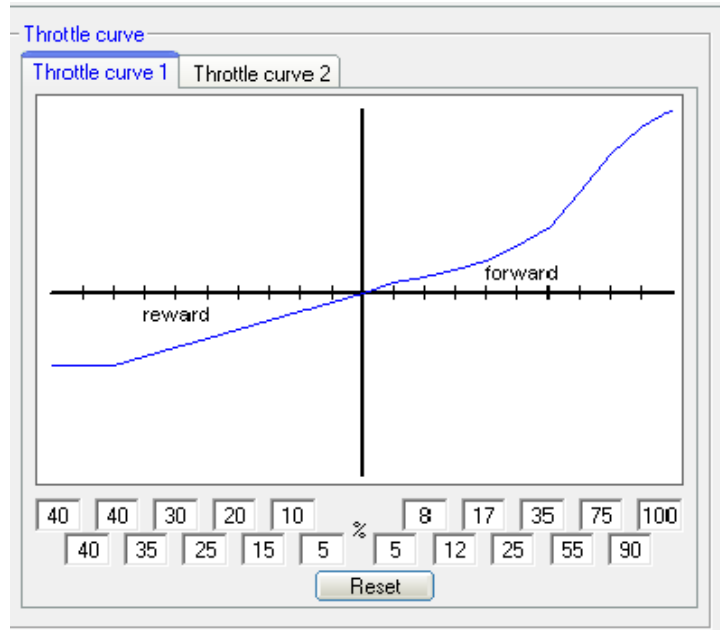

With „reset“ the curve returns to its initial values.

The throttle curve 2 can be activated with a function of control channel X3 while driving. This enables for example to use throttle curve 1 for normal driving and throttle curve 2 for maneuvering with very sensitive acceleration behaviour.

Example for normal driving:

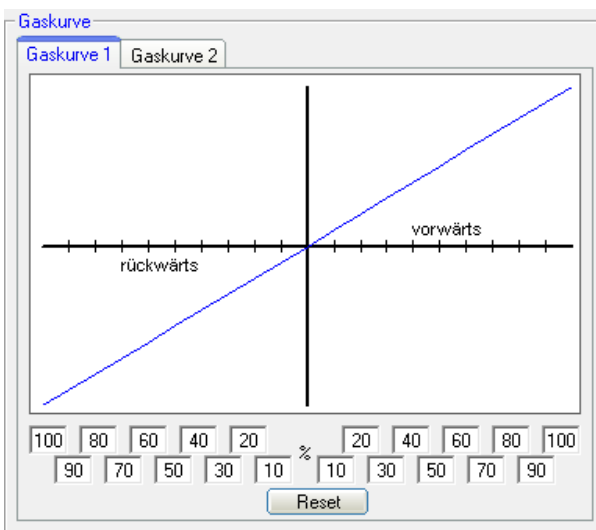

Example for maneuvering:

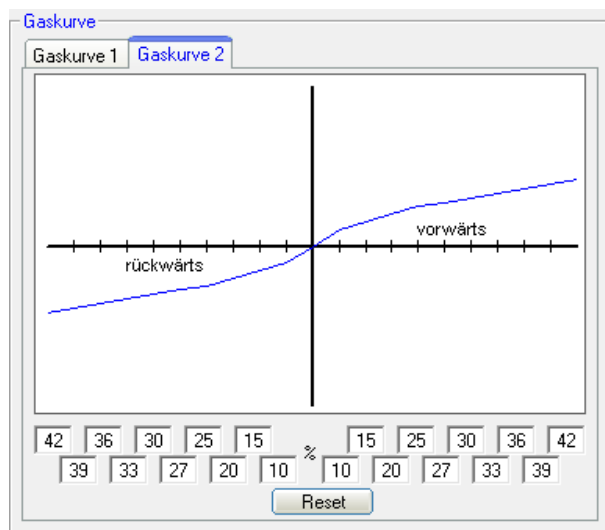

Configuration – Control channel X3

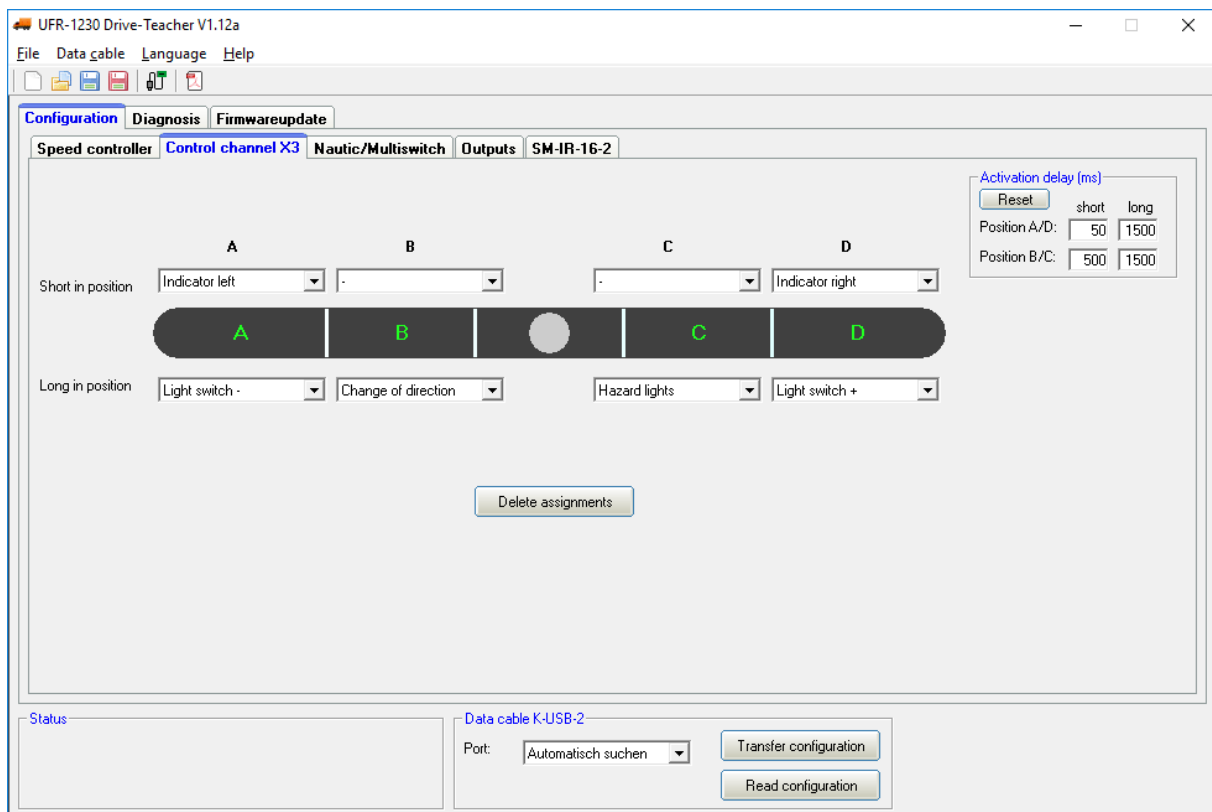

The picture shows the standard settings of the control channel X3.

All available additional functions for control channel X3 are listed on page 16.

Each of the 4 areas (A, B, C and D) can be set with 2 functions for short and long in position. The functions are always switched in „memory“ mode.

Each thresholds can be adjusted using the white line to define the area in which a function should be carried out.

Activation delay

For positions A, B, C and D activation delays can be set in milliseconds. These times define how long the control stick must be in the position in order to activate or deactivate a function. Times between 10 and 2500 ms are possible.

The button „Reset“ allows recovering the default settings of the parameters.

Configuration - Nautic/Multiswitch

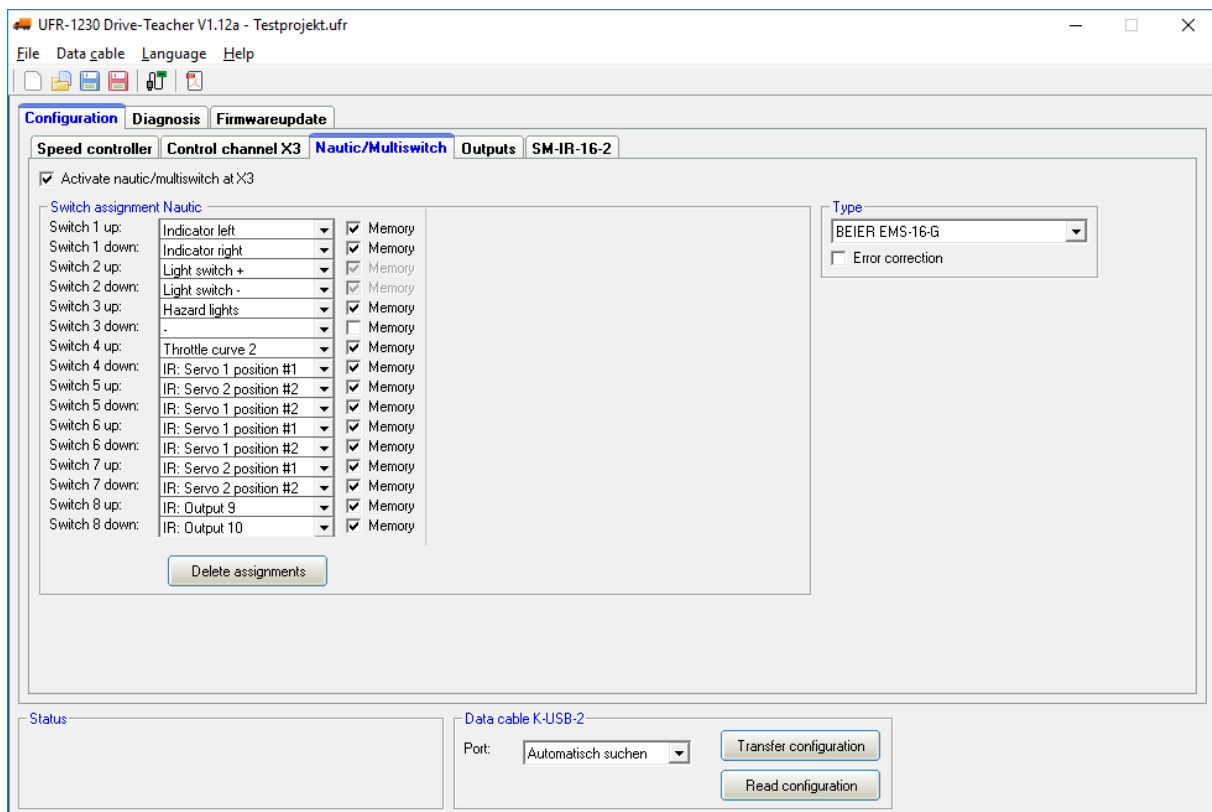

In the standard setting the nautic mode is deactivated.

Assignment of switches

For each switch position a function can be set (see page 16) optional with the option „memory“.

Type

Select your transmitter type in this box.

Error correction

For a better nautic transmission an error correction can be activated. With the error correction the nautic transmission takes a bit longer (approx. +200 ms). Especially with some 2,4 GHz transmitter the error correction is helpful in order to avoid disturbances and mal functions.

Manual setting

The transmission protokoll can be set manually with this setting. Only use this option under instruction. In most cases a manual setting is not required.

Configuration - outputs

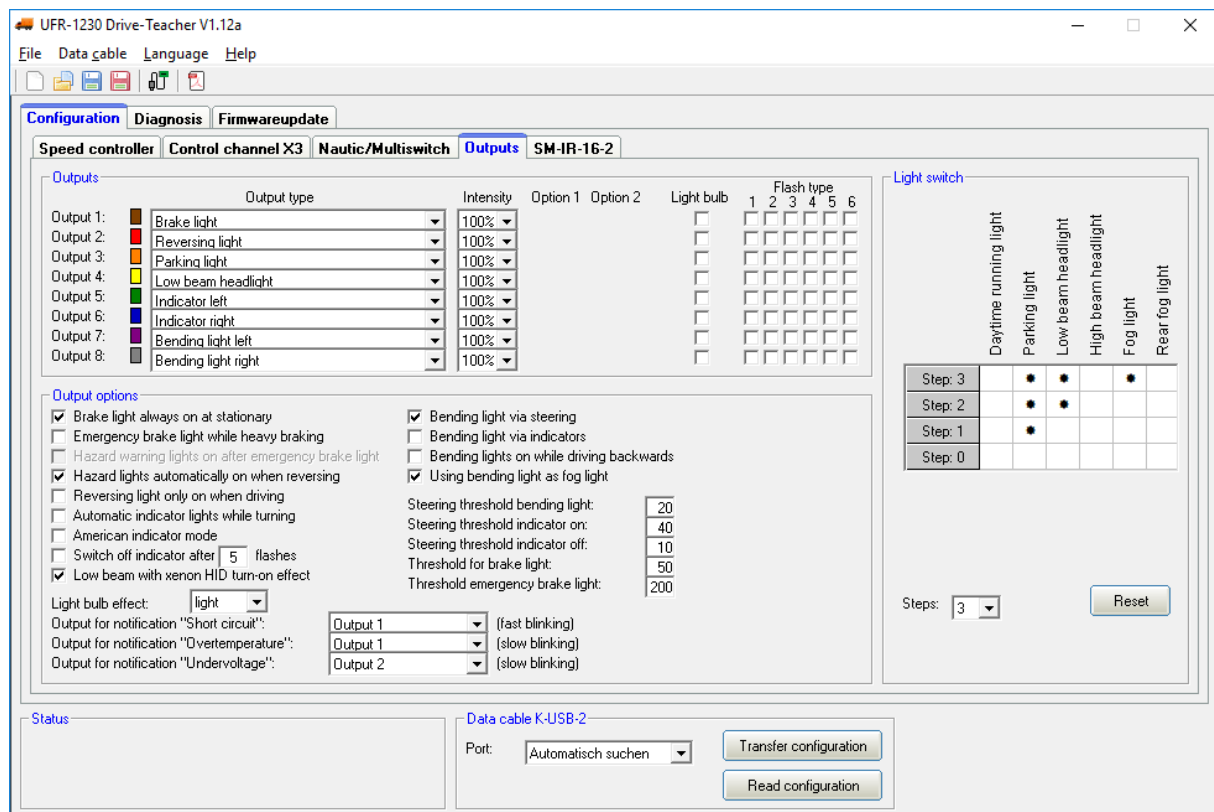

The picture shows the standard settings for output 1- 8.

The boxes indicate the colour of the flat ribbon cable for this output.

Output type

Different function can be assigned to this outputs (see page 16).

Intensity

For each output the light intensity can be set in 2 % steps.

Option 1 and option 2

Additional options are available for some outputs. More information can be found on page 21.

Flash type

The UFR-1230 offers 6 preset flash types (see page 24). The outputs can be assigned any flash types here. The flashers are all activated with the function "Flash", via the control channel X3, (or Nautic/Multiswitch).

Output options

With the function „Bake light always on at stationary“ the brake light always switches on as long as the model is standing.

With activated „Emergency brake light while heavy braking“ the brake light is flashing with a frequency of 3 Hz during heavy braking. If in addition the option “Hazard warning lights automatically on after emergency brake light” the hazard lights turn

automatically on after heavy braking. The lights remain on, as long as they are switched off manually or the vehicle starts moving.

With the option „Low beam with xenon HID turn-on effect“ the low beam lights switch on with the specific xenon effect (short flash with dimming).

The light bulb effect can be set in 3 levels: Light, medium and strong.

With the option „Hazard lights automatically on when reversing“ both indicators flash while the vehicle is driving backwards.

With the option „Automatic indicator lights while turning“ the indicators flash as soon as the steering channel (X2) is out of the neutral position. When driving straight ahead again the indicators are deactivated. With this option it is only possible to activate the indicators by the steering channel and not with the control channel (X3) any longer.

With the option „American indicator mode“ the indicators light, as soon as the parking light is switched on.

Bending lights can be switched with 3 different options:

With the option „via steering“ the right bending light switches on while turning right and the left while turning left.

With the option „Bending lights via indicator“ the bending lights are activated with the indicator lights.

A combination of both options is possible.

While driving backwards the bending lights can be activated, as well.

The bending lights can also be used as fog lights and can be switched with the light switch.

The steering thresholds for bending and indicator on / off lights can be set for steering channel X2 here.

The threshold for brake light defines how strong the brake must be hit in order to activate the brake light. The higher the threshold value, the harder the brake must be hit.

The threshold for emergency brake light determines how strongly the vehicle must be slowed down so that the emergency brake light is triggered.

The outputs for warning / notification lights (blinking) for „short circuit“, „overtemperature“ and „undervoltage“ can be set.

Light switch

The light switch is individually programmable with up to 6 steps. For each step different lights can be activated.

Using control channel X3 and the function „light switch +“ and „light switch -“ the steps can be changed.

When turning on the speed controller the light switch is always in step 0.

Light switch

	Daytime running light	Parking light	Low beam headlight	High beam headlight	Fog light	Rear fog light
Step: 3		•	•		•	
Step: 2		•	•			
Step: 1		•				
Step: 0						

Steps:

Reset

Configuration - SM-IR-16-2

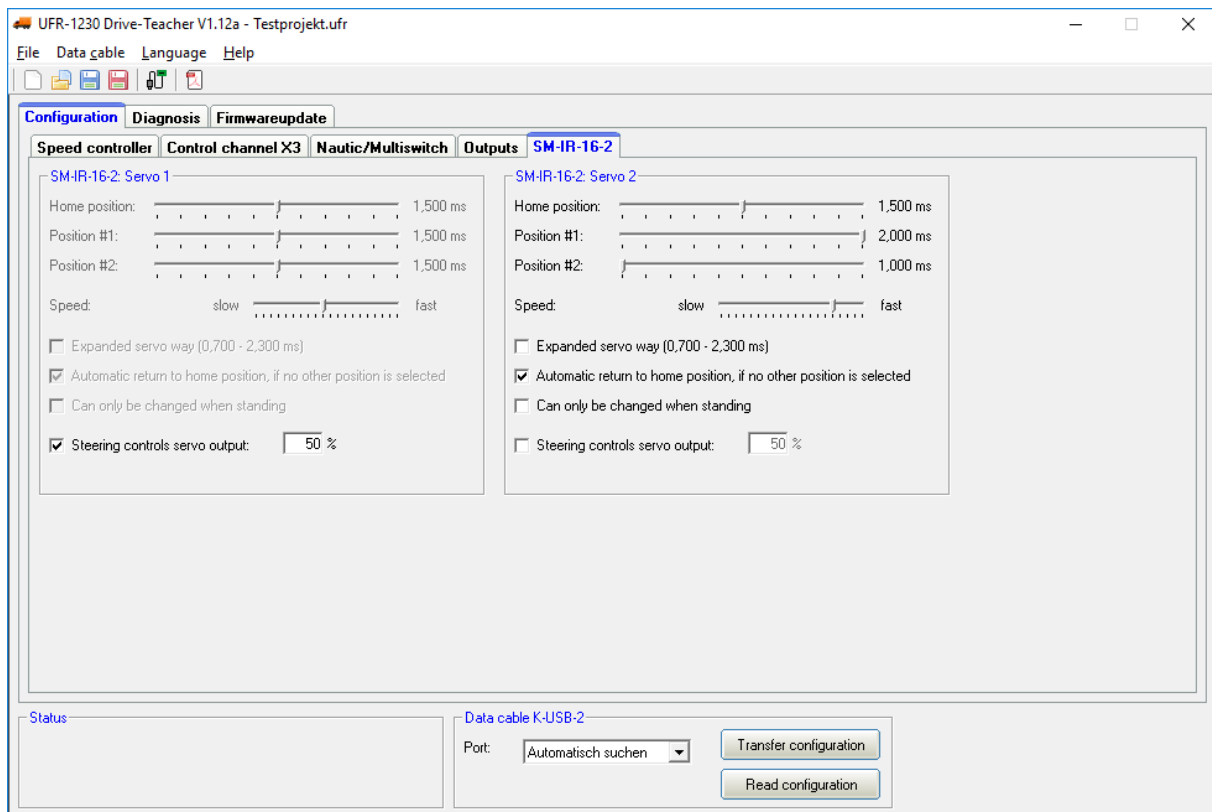

All configurations of the SM-IR-16-2 can be set here.

Home position

After switching on the speed controller the servos are always in this position.

Positions #1 - #2

With control channel X3 (additional functions) or with nautic/multiswitch modules the positions #1 and #2 can be controlled.

To change the servo way the slide bar can be moved with the cursor to the correct position.

Speed of servo

20 different speed steps are available for the servo movements. Each servo has its individual inertia. Even at the highest speed a servo might take a while to reach the position.

Expanded servo way

The normal impuls length of a servo is between 1,000 - 2,000 ms. With an expanded servo way it is possible to reach positions between 0,700 - 2,300 ms.

Attention!
Not all servos are suitable for an extended way and might get damaged!
Therefore use this function carefully!

Automatic return to home position, if no other position is selected

With this option the servo always returns to its home position, if neither position #1 nor #2 is activated. This option is helpful in case a motor is connected to the servo output.

If this option is not activated, the servo stops and remains at the last triggered position. Drive the servo at a very slow speed to a specific position.

Can only be changed when standing

With this option, servo positions at the light module SM-IR-16-2 can only be changed as long as the vehicle is not moving. This makes it, for example, impossible to lower trailer supports accidentally while driving.

Steering controls servo output

With this option the servo can be controlled by the steering channel X2. This enables to realise a steerable axis.

Diagnosis

The screenshot displays the 'Diagnosis' tab of the 'UFR-1230 Drive-Teacher V1.12a - Testprojekt.ufr' software. The interface is organized into several panels:

- Proportional inputs:** Shows three channels (X1, X2, X3) with values for pulse width (ms) and neutral position. X1: 1,334 ms, -33, 1,500 ms; X2: 1,703 ms, 40, 1,500 ms; X3: 1,909 ms, 81 A, 1,500 ms.
- Servo outputs:** Shows two channels (X4, X5) with pulse width values: X4: 1,342 ms; X5: 1,297 ms.
- Engine:** Shows U-Motor+ (523), U-Motor- (0), Voltage (432), Set value (-255), Value (176), PWM (-25,5%), and Braking PWM (0,0%).
- Miscellaneous:** Shows Battery voltage (9,38 V), Battery threshold (7,00 V), Temperature (28° C), Output current (0,00 A), Firmware (1.12a), and DIP switch (four indicators).
- Outputs:** Shows eight output channels (Output 1 to 8) with status indicators (green/red circles). Output 1 and 2 are green, Output 3 and 4 are grey, Output 5 and 6 are green, and Output 7 and 8 are grey. A 'Test' checkbox is present.
- Diagnosis recording:** Includes 'Start recording', 'Play recording', and 'Stop diagnosis' buttons. A recording time of 000.0 s is shown.
- Nautic/Multiswitch:** A 'read' button is present.
- Status:** Shows 'Data cable K-USB-2' with a port dropdown set to 'Automatisch suchen' and 'Transfer configuration' and 'Read configuration' buttons.

With the diagnosis function the different speed controller functions can be checked. The data cable K-USB-2 must be connected to X6/1 of the speed controller.

Proportional inputs

Shows values from the receiver for proportional channel 1 to 3. In neutral position the values in the middle should be 0.

A slight fluctuation of the three channels is normal and no indication for problems.

Servo outputs

Current values of servo outputs X4 and X5.

Motor

A few values for the motor output stage are shown here. These values are only for internal checks.

Various

The values in this field are mostly for internal checks.

Outputs

The 8 light outputs are shown in this field. An active output is shown green.

When activating the option „Test“ all 8 outputs are activated one by one as a running light. The wiring of all outputs can be checked using this function even if no transmitter is connected.

Nautic mode

With activated Nautic mode, the transmitted signals can be checked for example after installing a new multiswitch or for trouble shooting.

It is possible to record the diagnosis files on the hard disk. The speed controller needs to be connected to the computer with the data cable K-USM-2. A diagnosis during „normal“ driving is therefore not possible.

Firmware update

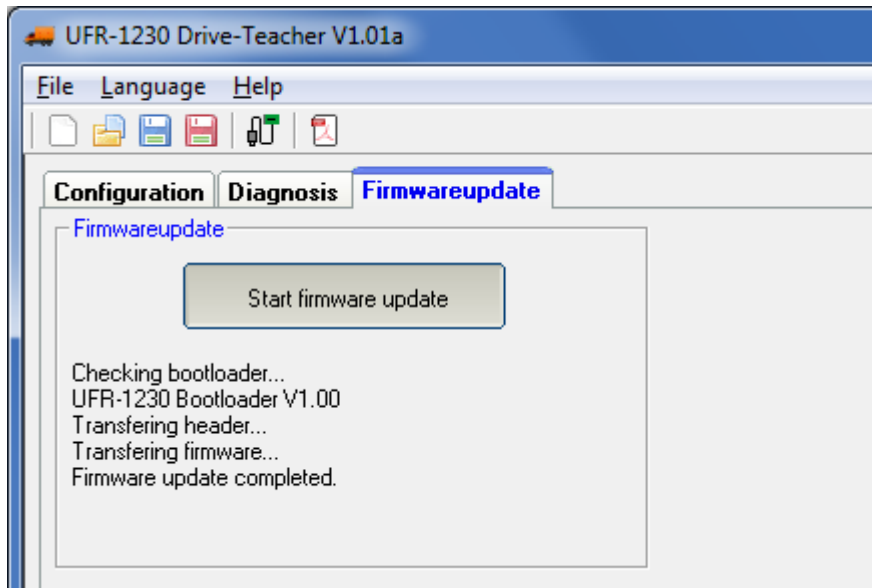

As soon as a new update is available you will get a notice from the Drive-Teacher. It is also possible to download the update manually.

With every update of the software the firmware for the speed controller is updated as well.

An update takes approx. 10 seconds. The red and blue LEDs are flashing a couple of times alternately.

Never disconnect the speed controller from supply voltage during the update!

